

## Low, Medium and High Pressure Adapters and Couplings

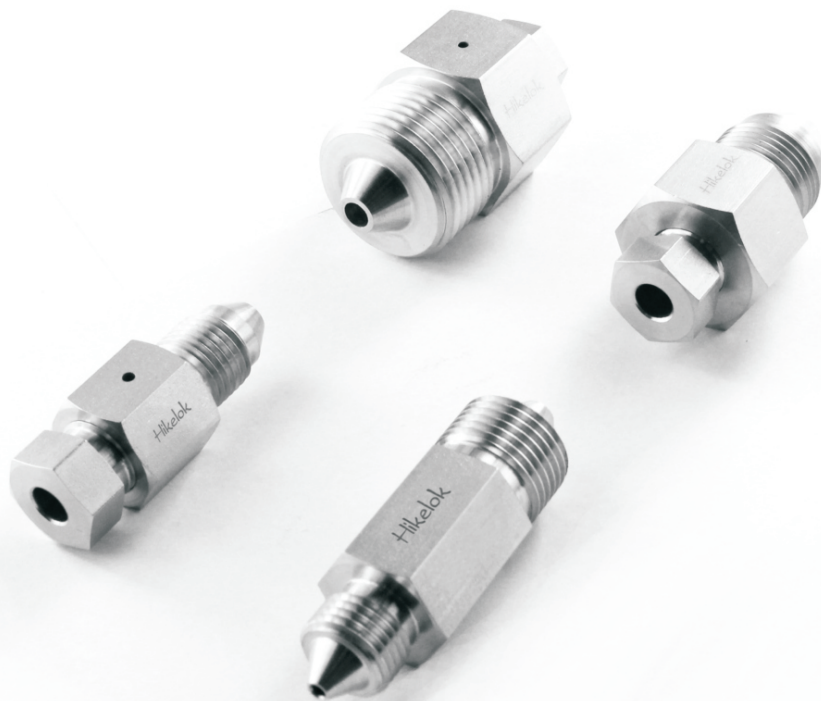

- ❖ Male to Male Adapters
- ❖ Male to Female Adapters
- ❖ Female to Male Adapters
- ❖ Female to Female Couplings

## Features

- ❖ Male to Male Adapters
- ❖ Male to Female Adapters
- ❖ Female to Male Adapters
- ❖ Female to Female Couplings
- ❖ Fittings can be manufactured to meet NACE MR0175/ISO 15156
- ❖ Antivibration connection components are available
- ❖ Strain-hardened 316 stainless steel standard, other materials available on request

## How to Order

- ❖ To order Hikelok low, medium and high pressure adapters and couplings, add the material designator(316, A825) to the ordering number.
- ❖ Low, medium and high pressure male end connection, one-piece design is standard, to order two-piece design add -TP to the ordering number

### End Connection Configuration, Size and Working Pressure

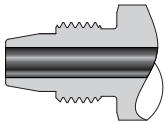
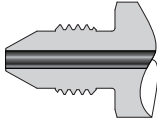
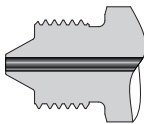
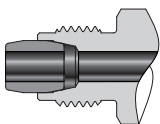
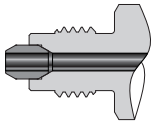
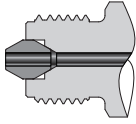
End Connection	Configuration	Size	Working Pressure psig (bar)
Low Pressure Male		1/8" : LPF2 1/4" : LPF4 3/8" : LPF6 1/2" : LPF8	15,000 (1,034)
Medium Pressure Male		1/4" : MPF4 3/8" : MPF6 9/16" : MPF9 3/4" : MPF12 1" : MPF16	20,000 (1,379)
High Pressure Male		1/4" : HPF4 3/8" : HPF6 9/16" : HPF9	60,000 (4,137)
Low Pressure Male (Two-piece Design)		1/8" : LPF2 1/4" : LPF4 3/8" : LPF6 1/2" : LPF8	15,000 (1,034)
Medium Pressure Male (Two-piece Design)		1/4" : MPF4 3/8" : MPF6 9/16" : MPF9 3/4" : MPF12 1" : MPF16	20,000 (1,379)
High Pressure Male (Two-piece Design)		1/4" : HPF4 3/8" : HPF6 9/16" : HPF9	60,000 (4,137)

**End Connection Configuration, Size and Working Pressure**

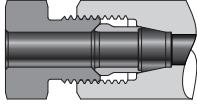
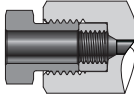
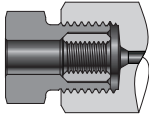
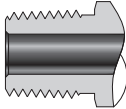
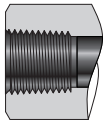
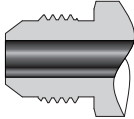
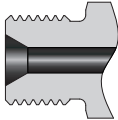
End Connection	Configuration	Size	Working Pressure psig (bar)
Low Pressure Female		1/8" : LPF2 1/4" : LPF4 3/8" : LPF6 1/2" : LPF8	15,000 (1,034)
Medium Pressure Female		1/4" : MPF4 3/8" : MPF6 9/16" : MPF9 3/4" : MPF12 1" : MPF16	20,000 (1,379)
High Pressure Female		1/4" : HPF4 3/8" : HPF6 9/16" : HPF9	60,000 (4,137)
Male NPT Thread		1/4" : NPT4 3/8" : NPT6 1/2" : NPT8	15,000 (1,034)
		3/4" : NPT12 1" : NPT16	10,000 (689)
Female NPT Thread		1/4" : FNPT4 3/8" : FNPT6 1/2" : FNPT8	15,000 (1,034)
		3/4" : FNPT12 1" : FNPT16	10,000 (689)
Male JIC		7/16-20: AN4 9/16-18: AN6 3/4-16: AN8 7/8-14: AN10	20,000 (1,379)
		1-1/16-12: AN12 1-5/16-12: AN16	15,000 (1,034)
Type M hose		9/16-18: RH9 3/4-16: RH12 7/8-14: RH14	30,000 (2,068)
		1-12: RH16 1-5/16-12: RH21	20,000 (1,379)

## Low Pressure Male to Low Pressure Male

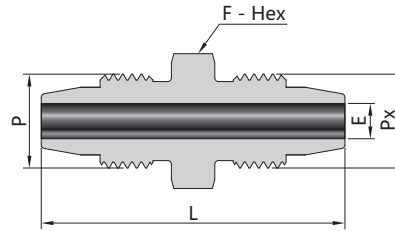

### Low Pressure Male

### Low Pressure Male

P-Connection Type	PX-Connection Type	Ordering Number	Dimension, in. (mm)			Working Pressure psig (bar)
			L	F	E	
LPF2	LPF2	LPF2-MTM-LPF2-	1.37 (34.9)	0.50 (12.7)	0.09 (2.4)	15000 (1034)
LPF4	LPF2	LPF4-MTM-LPF2-	1.63 (41.3)	0.63 (15.9)	0.09 (2.4)	15000 (1034)
LPF4	LPF4	LPF4-MTM-LPF4-	1.75 (44.5)	0.63 (15.9)	0.19 (4.8)	15000 (1034)
LPF6	LPF2	LPF6-MTM-LPF2-	1.69 (42.9)	0.75 (19.1)	0.09 (2.4)	15000 (1034)
LPF6	LPF4	LPF6-MTM-LPF4-	1.87 (47.6)	0.75 (19.1)	0.19 (4.8)	15000 (1034)
LPF6	LPF6	LPF6-MTM-LPF6-	1.87 (47.6)	0.75 (19.1)	0.25 (6.4)	15000 (1034)
LPF8	LPF2	LPF8-MTM-LPF2-	1.81 (46.0)	0.94 (23.8)	0.09 (2.4)	15000 (1034)
LPF8	LPF4	LPF8-MTM-LPF4-	2.00 (50.8)	0.94 (23.8)	0.19 (4.8)	15000 (1034)
LPF8	LPF6	LPF8-MTM-LPF6-	2.00 (50.8)	0.94 (23.8)	0.25 (6.4)	15000 (1034)
LPF8	LPF8	LPF8-MTM-LPF8-	2.06 (52.4)	0.94 (23.8)	0.37 (9.5)	15000 (1034)

## Low Pressure Male to Male NPT Threads

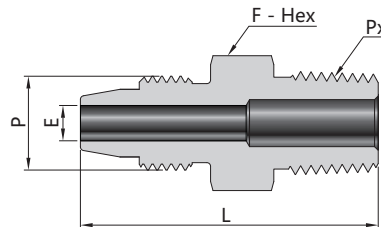

### Low Pressure Male

### Male NPT Threads

P-Connection Type	PX-Connection Type	Ordering Number	Dimension, in. (mm)			Working Pressure psig (bar)
			L	F	E	
LPF2	1/8 NPT	LPF2-MTM-NPT2-	1.19 (30.2)	0.50 (12.7)	0.09 (2.4)	15000 (1034)
LPF2	1/4 NPT	LPF2-MTM-NPT4-	1.44 (36.5)	0.56 (14.3)	0.09 (2.4)	15000 (1034)
LPF2	3/8 NPT	LPF2-MTM-NPT6-	1.50 (38.1)	0.69 (17.5)	0.09 (2.4)	15000 (1034)
LPF2	1/2 NPT	LPF2-MTM-NPT8-	1.75 (44.5)	0.87 (22.2)	0.09 (2.4)	15000 (1034)
LPF2	3/4 NPT	LPF2-MTM-NPT12-	1.81 (46.0)	1.06 (27.0)	0.09 (2.4)	10000 (690)
LPF2	1 NPT	LPF2-MTM-NPT16-	2.13 (54.0)	1.37 (34.9)	0.09 (2.4)	10000 (690)
LPF4	1/8 NPT	LPF4-MTM-NPT2-	1.44 (36.5)	0.63 (15.9)	0.19 (4.8)	15000 (1034)
LPF4	1/4 NPT	LPF4-MTM-NPT4-	1.63 (41.3)	0.63 (15.9)	0.19 (4.8)	15000 (1034)
LPF4	3/8 NPT	LPF4-MTM-NPT6-	1.63 (41.3)	0.69 (17.5)	0.19 (4.8)	15000 (1034)
LPF4	1/2 NPT	LPF4-MTM-NPT8-	1.87 (47.6)	0.87 (22.2)	0.19 (4.8)	15000 (1034)
LPF4	3/4 NPT	LPF4-MTM-NPT12-	1.94 (49.2)	1.06 (27.0)	0.19 (4.8)	10000 (690)
LPF4	1 NPT	LPF4-MTM-NPT16-	2.25 (57.2)	1.37 (34.9)	0.19 (4.8)	10000 (690)

**Low Pressure Male**

**Male NPT Threads**

P-Connection Type	PX-Connection Type	Ordering Number	Dimension, in. (mm)			Working Pressure psig (bar)
			L	F	E	
LPF6	1/8 NPT	LPF6-MTM-NPT2-	1.50 (38.1)	0.75 (19.1)	0.19 (4.8)	15000 (1034)
LPF6	1/4 NPT	LPF6-MTM-NPT4-	1.69 (42.9)	0.75 (19.1)	0.25 (6.4)	15000 (1034)
LPF6	3/8 NPT	LPF6-MTM-NPT6-	1.69 (42.9)	0.75 (19.1)	0.25 (6.4)	15000 (1034)
LPF6	1/2 NPT	LPF6-MTM-NPT8-	1.94 (49.2)	0.87 (22.2)	0.25 (6.4)	15000 (1034)
LPF6	3/4 NPT	LPF6-MTM-NPT12-	2.00 (50.8)	1.06 (27.0)	0.25 (6.4)	10000 (690)
LPF6	1 NPT	LPF6-MTM-NPT16-	2.31 (58.7)	1.37 (34.9)	0.25 (6.4)	10000 (690)
LPF8	1/8 NPT	LPF8-MTM-NPT2-	1.63 (41.3)	0.94 (23.8)	0.19 (4.8)	15000 (1034)
LPF8	1/4 NPT	LPF8-MTM-NPT4-	1.81 (46.0)	0.94 (23.8)	0.25 (6.4)	15000 (1034)
LPF8	3/8 NPT	LPF8-MTM-NPT6-	1.81 (46.0)	0.94 (23.8)	0.31 (7.9)	15000 (1034)
LPF8	1/2 NPT	LPF8-MTM-NPT8-	2.00 (50.8)	0.94 (23.8)	0.37 (9.5)	15000 (1034)
LPF8	3/4 NPT	LPF8-MTM-NPT12-	2.06 (52.4)	1.06 (27.0)	0.37 (9.5)	10000 (690)
LPF8	1 NPT	LPF8-MTM-NPT16-	2.37 (60.3)	1.37 (34.9)	0.37 (9.5)	10000 (690)

**Low Pressure Male to Male JIC**

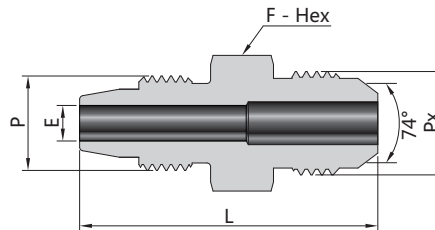

**Low Pressure Male**

**Male JIC**

P-Connection Type	PX-Connection Type	Ordering Number	Dimension, in. (mm)			Working Pressure psig (bar)
			L	F	E	
LPF2	1/4 JIC	LPF2-MTM-AN4-	1.37 (34.9)	0.50 (12.7)	0.09 (2.4)	15000 (1034)
LPF2	3/8 JIC	LPF2-MTM-AN6-	1.44 (36.5)	0.63 (15.9)	0.09 (2.4)	15000 (1034)
LPF2	1/2 JIC	LPF2-MTM-AN8-	1.63 (41.3)	0.81 (20.6)	0.09 (2.4)	15000 (1034)
LPF2	5/8 JIC	LPF2-MTM-AN10-	1.75 (44.5)	0.94 (23.8)	0.09 (2.4)	15000 (1034)
LPF2	3/4 JIC	LPF2-MTM-AN12-	1.94 (49.2)	1.13 (28.6)	0.09 (2.4)	15000 (1034)
LPF2	1 JIC	LPF2-MTM-AN16-	2.06 (52.4)	1.37 (34.9)	0.09 (2.4)	15000 (1034)
LPF4	1/4 JIC	LPF4-MTM-AN4-	1.63 (41.3)	0.63 (15.9)	0.17 (4.4)	15000 (1034)
LPF4	3/8 JIC	LPF4-MTM-AN6-	1.63 (41.3)	0.63 (15.9)	0.19 (4.8)	15000 (1034)
LPF4	1/2 JIC	LPF4-MTM-AN8-	1.75 (44.5)	0.81 (20.6)	0.19 (4.8)	15000 (1034)
LPF4	5/8 JIC	LPF4-MTM-AN10-	1.94 (49.2)	0.94 (23.8)	0.19 (4.8)	15000 (1034)
LPF4	3/4 JIC	LPF4-MTM-AN12-	2.06 (52.4)	1.13 (28.6)	0.19 (4.8)	15000 (1034)
LPF4	1 JIC	LPF4-MTM-AN16-	2.25 (57.2)	1.37 (34.9)	0.19 (4.8)	15000 (1034)
LPF6	1/4 JIC	LPF6-MTM-AN4-	1.69 (42.9)	0.75 (19.1)	0.17 (4.4)	15000 (1034)
LPF6	3/8 JIC	LPF6-MTM-AN6-	1.69 (42.9)	0.75 (19.1)	0.23 (5.8)	15000 (1034)
LPF6	1/2 JIC	LPF6-MTM-AN8-	1.81 (46.0)	0.81 (20.6)	0.25 (6.4)	15000 (1034)
LPF6	5/8 JIC	LPF6-MTM-AN10-	1.94 (49.2)	0.94 (23.8)	0.25 (6.4)	15000 (1034)
LPF6	3/4 JIC	LPF6-MTM-AN12-	2.13 (54.0)	1.13 (28.6)	0.25 (6.4)	15000 (1034)
LPF6	1 JIC	LPF6-MTM-AN16-	2.25 (57.2)	1.37 (34.9)	0.25 (6.4)	15000 (1034)
LPF8	1/4 JIC	LPF8-MTM-AN4-	1.81 (46.0)	0.94 (23.8)	0.17 (4.4)	15000 (1034)
LPF8	3/8 JIC	LPF8-MTM-AN6-	1.81 (46.0)	0.94 (23.8)	0.23 (5.8)	15000 (1034)
LPF8	1/2 JIC	LPF8-MTM-AN8-	1.94 (49.2)	0.94 (23.8)	0.31 (8.0)	15000 (1034)
LPF8	5/8 JIC	LPF8-MTM-AN10-	2.00 (50.8)	0.94 (23.8)	0.37 (9.4)	15000 (1034)
LPF8	3/4 JIC	LPF8-MTM-AN12-	2.19 (55.6)	1.13 (28.6)	0.37 (9.5)	15000 (1034)
LPF8	1 JIC	LPF8-MTM-AN16-	2.31 (58.7)	1.37 (34.9)	0.37 (9.5)	15000 (1034)

## Low Pressure Male to Type M hose Male

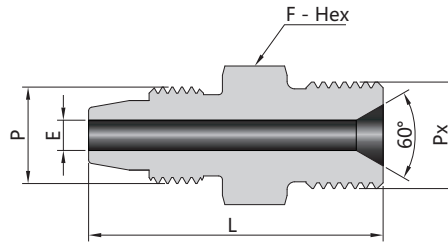

### Low Pressure Male

### Type M hose Male

P-Connection Type	PX-Connection Type	Ordering Number	Dimension, in. (mm)			Working Pressure psig (bar)
			L	F	E	
LPF2	RH9	LPF2-MTM-RH9-	1.38 (35.1)	0.63 (15.9)	0.09 (2.4)	15000 (1034)
LPF2	RH12	LPF2-MTM-RH12-	1.55 (39.4)	0.75 (19.1)	0.09 (2.4)	15000 (1034)
LPF2	RH14	LPF2-MTM-RH14-	1.76 (44.6)	1.00 (25.4)	0.09 (2.4)	15000 (1034)
LPF2	RH16	LPF2-MTM-RH16-	1.64 (41.7)	1.00 (25.4)	0.09 (2.4)	15000 (1034)
LPF2	RH21	LPF2-MTM-RH21-	1.76 (44.7)	1.37 (34.9)	0.09 (2.4)	15000 (1034)
LPF4	RH9	LPF4-MTM-RH9-	1.54 (39.0)	0.63 (15.9)	0.09 (2.4)	15000 (1034)
LPF4	RH12	LPF4-MTM-RH12-	1.70 (43.3)	0.75 (19.1)	0.19 (4.8)	15000 (1034)
LPF4	RH14	LPF4-MTM-RH14-	1.91 (48.5)	1.00 (25.4)	0.15 (3.8)	15000 (1034)
LPF4	RH16	LPF4-MTM-RH16-	1.80 (45.6)	1.00 (25.4)	0.19 (4.8)	15000 (1034)
LPF4	RH21	LPF4-MTM-RH21-	1.91 (48.6)	1.37 (34.9)	0.19 (4.8)	15000 (1034)
LPF6	RH9	LPF6-MTM-RH9-	1.63 (41.3)	0.75 (19.1)	0.09 (2.4)	15000 (1034)
LPF6	RH12	LPF6-MTM-RH12-	1.76 (44.6)	0.75 (19.1)	0.25 (6.4)	15000 (1034)
LPF6	RH14	LPF6-MTM-RH14-	1.95 (49.6)	1.00 (25.4)	0.15 (3.8)	15000 (1034)
LPF6	RH16	LPF6-MTM-RH16-	1.85 (46.9)	1.00 (25.4)	0.25 (6.4)	15000 (1034)
LPF6	RH21	LPF6-MTM-RH21-	1.96 (49.9)	1.37 (34.9)	0.25 (6.4)	15000 (1034)
LPF8	RH9	LPF8-MTM-RH9-	1.73 (44.0)	0.94 (23.8)	0.09 (2.4)	15000 (1034)
LPF8	RH12	LPF8-MTM-RH12-	1.86 (47.3)	0.94 (23.8)	0.29 (7.4)	15000 (1034)
LPF8	RH14	LPF8-MTM-RH14-	2.01 (51.1)	1.00 (25.4)	0.15 (3.8)	15000 (1034)
LPF8	RH16	LPF8-MTM-RH16-	1.90 (48.2)	1.00 (25.4)	0.37 (9.5)	15000 (1034)
LPF8	RH21	LPF8-MTM-RH21-	2.02 (51.2)	1.37 (34.9)	0.37 (9.5)	15000 (1034)

## Medium Pressure Male to Low Pressure Male

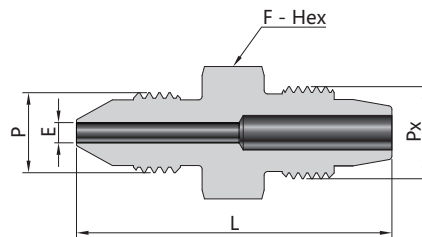

### Medium Pressure Male

### Low Pressure Male

P-Connection Type	PX-Connection Type	Ordering Number	Dimension, in. (mm)			Working Pressure psig (bar)
			L	F	E	
MPF4	LPF2	MPF4-MTM-LPF2-	1.50 (38.1)	0.50 (12.7)	0.09 (2.4)	15000 (1034)
MPF4	LPF4	MPF4-MTM-LPF4-	1.75 (44.5)	0.63 (15.9)	0.11 (2.8)	15000 (1034)
MPF4	LPF6	MPF4-MTM-LPF6-	1.81 (46.0)	0.75 (19.1)	0.11 (2.8)	15000 (1034)
MPF4	LPF8	MPF4-MTM-LPF8-	1.94 (49.2)	0.94 (23.8)	0.11 (2.8)	15000 (1034)
MPF6	LPF2	MPF6-MTM-LPF2-	1.75 (44.5)	0.63 (15.9)	0.09 (2.4)	15000 (1034)
MPF6	LPF4	MPF6-MTM-LPF4-	1.87 (47.6)	0.63 (15.9)	0.19 (4.8)	15000 (1034)

Medium Pressure Male

Low Pressure Male

P-Connection Type	PX-Connection Type	Ordering Number	Dimension, in. (mm)			Working Pressure psig (bar)
			L	F	E	
MPF6	LPF6	MPF6-MTM-LPF6-	1.94 (49.2)	0.75 (19.1)	0.20 (5.2)	15000 (1034)
MPF6	LPF8	MPF6-MTM-LPF8-	2.06 (52.4)	0.94 (23.8)	0.20 (5.2)	15000 (1034)
MPF9	LPF2	MPF9-MTM-LPF2-	2.00 (50.8)	0.94 (23.8)	0.09 (2.4)	15000 (1034)
MPF9	LPF4	MPF9-MTM-LPF4-	2.19 (55.6)	0.94 (23.8)	0.19 (4.8)	15000 (1034)
MPF9	LPF6	MPF9-MTM-LPF6-	2.19 (55.6)	0.94 (23.8)	0.25 (6.4)	15000 (1034)
MPF9	LPF8	MPF9-MTM-LPF8-	2.25 (57.2)	0.94 (23.8)	0.31 (7.9)	15000 (1034)
MPF12	LPF2	MPF12-MTM-LPF2-	2.25 (57.2)	1.19 (30.2)	0.09 (2.4)	15000 (1034)
MPF12	LPF4	MPF12-MTM-LPF4-	2.44 (61.9)	1.19 (30.2)	0.19 (4.8)	15000 (1034)
MPF12	LPF6	MPF12-MTM-LPF6-	2.50 (63.5)	1.19 (30.2)	0.25 (6.4)	15000 (1034)
MPF12	LPF8	MPF12-MTM-LPF8-	2.50 (63.5)	1.19 (30.2)	0.37 (9.5)	15000 (1034)
MPF16	LPF2	MPF16-MTM-LPF2-	2.81 (71.4)	1.50 (38.1)	0.09 (2.4)	15000 (1034)
MPF16	LPF4	MPF16-MTM-LPF4-	3.00 (76.2)	1.50 (38.1)	0.19 (4.8)	15000 (1034)
MPF16	LPF6	MPF16-MTM-LPF6-	3.06 (77.8)	1.50 (38.1)	0.37 (9.5)	15000 (1034)
MPF16	LPF8	MPF16-MTM-LPF8-	3.06 (77.8)	1.50 (38.1)	0.37 (9.5)	15000 (1034)

Medium Pressure Male to Medium Pressure Male

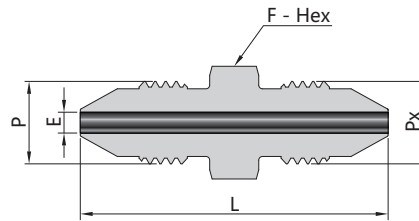

Medium Pressure Male

Medium Pressure Male

P-Connection Type	PX-Connection Type	Ordering Number	Dimension, in. (mm)			Working Pressure psig (bar)
			L	F	E	
MPF4	MPF4	MPF4-MTM-MPF4-	1.63 (41.3)	0.50 (12.7)	0.11 (2.8)	20000 (1379)
MPF6	MPF4	MPF6-MTM-MPF4-	1.87 (47.6)	0.63 (15.9)	0.11 (2.8)	20000 (1379)
MPF6	MPF6	MPF6-MTM-MPF6-	2.00 (50.8)	0.63 (15.9)	0.20 (5.2)	20000 (1379)
MPF9	MPF4	MPF9-MTM-MPF4-	2.13 (54.0)	0.94 (23.8)	0.11 (2.8)	20000 (1379)
MPF9	MPF6	MPF9-MTM-MPF6-	2.31 (58.7)	0.94 (23.8)	0.20 (5.2)	20000 (1379)
MPF9	MPF9	MPF9-MTM-MPF9-	2.50 (63.5)	0.94 (23.8)	0.31 (7.9)	20000 (1379)
MPF12	MPF4	MPF12-MTM-MPF4-	2.44 (61.9)	1.19 (30.2)	0.11 (2.8)	20000 (1379)
MPF12	MPF6	MPF12-MTM-MPF6-	2.56 (65.1)	1.19 (30.2)	0.20 (5.2)	20000 (1379)
MPF12	MPF9	MPF12-MTM-MPF9-	2.75 (69.9)	1.19 (30.2)	0.31 (7.9)	20000 (1379)
MPF12	MPF12	MPF12-MTM-MPF12-	2.94 (74.6)	1.19 (30.2)	0.44 (11.1)	20000 (1379)
MPF16	MPF4	MPF16-MTM-MPF4-	3.00 (76.2)	1.50 (38.1)	0.11 (2.8)	20000 (1379)
MPF16	MPF6	MPF16-MTM-MPF6-	3.13 (79.4)	1.50 (38.1)	0.20 (5.2)	20000 (1379)
MPF16	MPF9	MPF16-MTM-MPF9-	3.31 (84.2)	1.50 (38.1)	0.31 (7.9)	20000 (1379)
MPF16	MPF12	MPF16-MTM-MPF12-	3.44 (87.4)	1.50 (38.1)	0.44 (11.1)	20000 (1379)
MPF16	MPF16	MPF16-MTM-MPF16-	3.94 (100.2)	1.50 (38.1)	0.56 (14.3)	20000 (1379)

## Medium Pressure Male to Male NPT Threads

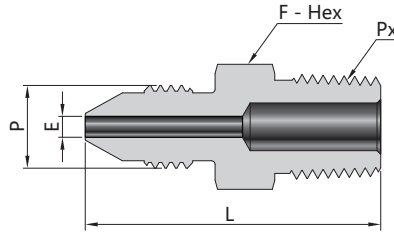

### Medium Pressure Male

### Male NPT Threads

P-Connection Type	PX-Connection Type	Ordering Number	Dimension, in. (mm)			Working Pressure psig (bar)
			L	F	E	
MPF4	1/8 NPT	MPF4-MTM-NPT2-	1.37 (34.9)	0.50 (12.7)	0.11 (2.8)	15000 (1034)
MPF4	1/4 NPT	MPF4-MTM-NPT4-	1.56 (39.7)	0.56 (14.3)	0.11 (2.8)	15000 (1034)
MPF4	3/8 NPT	MPF4-MTM-NPT6-	1.63 (41.3)	0.69 (17.5)	0.11 (2.8)	15000 (1034)
MPF4	1/2 NPT	MPF4-MTM-NPT8-	1.87 (47.6)	0.87 (22.2)	0.11 (2.8)	15000 (1034)
MPF4	3/4 NPT	MPF4-MTM-NPT12-	1.94 (49.2)	1.06 (27.0)	0.11 (2.8)	10000 (690)
MPF4	1 NPT	MPF4-MTM-NPT16-	2.25 (57.2)	1.37 (34.9)	0.11 (2.8)	10000 (690)
MPF6	1/8 NPT	MPF6-MTM-NPT2-	1.56 (39.7)	0.63 (15.9)	0.19 (4.8)	15000 (1034)
MPF6	1/4 NPT	MPF6-MTM-NPT4-	1.75 (44.5)	0.63 (15.9)	0.20 (5.2)	15000 (1034)
MPF6	3/8 NPT	MPF6-MTM-NPT6-	1.75 (44.5)	0.69 (17.5)	0.20 (5.2)	15000 (1034)
MPF6	1/2 NPT	MPF6-MTM-NPT8-	2.00 (50.8)	0.87 (22.2)	0.20 (5.2)	15000 (1034)
MPF6	3/4 NPT	MPF6-MTM-NPT12-	2.06 (52.4)	1.06 (27.0)	0.20 (5.2)	10000 (690)
MPF6	1 NPT	MPF6-MTM-NPT16-	2.37 (60.3)	1.37 (34.9)	0.20 (5.2)	10000 (690)
MPF9	1/8 NPT	MPF9-MTM-NPT2-	1.87 (47.6)	0.94 (23.8)	0.19 (4.8)	15000 (1034)
MPF9	1/4 NPT	MPF9-MTM-NPT4-	2.06 (52.4)	0.94 (23.8)	0.25 (6.4)	15000 (1034)
MPF9	3/8 NPT	MPF9-MTM-NPT6-	2.06 (52.4)	0.94 (23.8)	0.31 (7.9)	15000 (1034)
MPF9	1/2 NPT	MPF9-MTM-NPT8-	2.25 (57.2)	0.94 (23.8)	0.31 (7.9)	15000 (1034)
MPF9	3/4 NPT	MPF9-MTM-NPT12-	2.31 (58.7)	1.06 (27.0)	0.31 (7.9)	10000 (690)
MPF9	1 NPT	MPF9-MTM-NPT16-	2.56 (65.1)	1.37 (34.9)	0.31 (7.9)	10000 (690)
MPF12	1/8 NPT	MPF12-MTM-NPT2-	2.13 (54.0)	1.19 (30.2)	0.19 (4.8)	15000 (1034)
MPF12	1/4 NPT	MPF12-MTM-NPT4-	2.31 (58.7)	1.19 (30.2)	0.25 (6.4)	15000 (1034)
MPF12	3/8 NPT	MPF12-MTM-NPT6-	2.31 (58.7)	1.19 (30.2)	0.31 (7.9)	15000 (1034)
MPF12	1/2 NPT	MPF12-MTM-NPT8-	2.50 (63.5)	1.19 (30.2)	0.38 (9.6)	15000 (1034)
MPF12	3/4 NPT	MPF12-MTM-NPT12-	2.50 (63.5)	1.19 (30.2)	0.44 (11.1)	10000 (690)
MPF12	1 NPT	MPF12-MTM-NPT16-	2.75 (69.9)	1.37 (34.9)	0.44 (11.1)	10000 (690)
MPF16	1/8 NPT	MPF16-MTM-NPT2-	2.69 (68.3)	1.50 (38.1)	0.19 (4.8)	15000 (1034)
MPF16	1/4 NPT	MPF16-MTM-NPT4-	2.81 (71.4)	1.50 (38.1)	0.25 (6.4)	15000 (1034)
MPF16	3/8 NPT	MPF16-MTM-NPT6-	2.81 (71.4)	1.50 (38.1)	0.31 (7.9)	15000 (1034)
MPF16	1/2 NPT	MPF16-MTM-NPT8-	3.06 (77.8)	1.50 (38.1)	0.38 (9.6)	15000 (1034)
MPF16	3/4 NPT	MPF16-MTM-NPT12-	3.06 (82.6)	1.50 (38.1)	0.56 (14.3)	10000 (690)
MPF16	1 NPT	MPF16-MTM-NPT16-	3.25 (82.6)	1.50 (38.1)	0.56 (14.3)	10000 (690)



## Medium Pressure Male to Male JIC

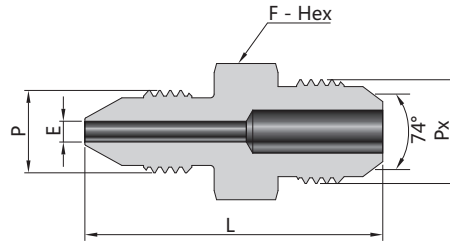

### Medium Pressure Male

### Male JIC

P-Connection Type	PX-Connection Type	Ordering Number	Dimension, in. (mm)			Working Pressure psig (bar)
			L	F	E	
MPF4	1/4 JIC	MPF4-MTM-AN4-	1.50 (38.1)	0.50 (12.7)	0.11 (2.8)	20000 (1379)
MPF4	3/8 JIC	MPF4-MTM-AN6-	1.63 (41.3)	0.63 (15.9)	0.11 (2.8)	20000 (1379)
MPF4	1/2 JIC	MPF4-MTM-AN8-	1.75 (44.5)	0.81 (20.6)	0.11 (2.8)	20000 (1379)
MPF4	5/8 JIC	MPF4-MTM-AN10-	1.87 (47.6)	0.94 (23.8)	0.11 (2.8)	20000 (1379)
MPF4	3/4 JIC	MPF4-MTM-AN12-	2.06 (52.4)	1.13 (28.6)	0.11 (2.8)	15000 (1034)
MPF4	1 JIC	MPF4-MTM-AN16-	2.19 (55.6)	1.37 (34.9)	0.11 (2.8)	15000 (1034)
MPF6	1/4 JIC	MPF6-MTM-AN4-	1.75 (44.5)	0.63 (15.9)	0.17 (4.4)	20000 (1379)
MPF6	3/8 JIC	MPF6-MTM-AN6-	1.75 (44.5)	0.63 (15.9)	0.20 (5.2)	20000 (1379)
MPF6	1/2 JIC	MPF6-MTM-AN8-	1.87 (47.6)	0.81 (20.6)	0.20 (5.2)	20000 (1379)
MPF6	5/8 JIC	MPF6-MTM-AN10-	2.06 (52.4)	0.94 (23.8)	0.20 (5.2)	20000 (1379)
MPF6	3/4 JIC	MPF6-MTM-AN12-	2.25 (57.2)	1.13 (28.6)	0.20 (5.2)	15000 (1034)
MPF6	1 JIC	MPF6-MTM-AN16-	2.37 (60.3)	1.37 (34.9)	0.20 (5.2)	15000 (1034)
MPF9	1/4 JIC	MPF9-MTM-AN4-	2.00 (50.8)	0.94 (23.8)	0.17 (4.4)	20000 (1379)
MPF9	3/8 JIC	MPF9-MTM-AN6-	2.06 (52.4)	0.94 (23.8)	0.23 (5.8)	20000 (1379)
MPF9	1/2 JIC	MPF9-MTM-AN8-	2.13 (54.0)	0.94 (23.8)	0.31 (7.9)	20000 (1379)
MPF9	5/8 JIC	MPF9-MTM-AN10-	2.25 (57.2)	0.94 (23.8)	0.31 (7.9)	20000 (1379)
MPF9	3/4 JIC	MPF9-MTM-AN12-	2.44 (61.9)	1.13 (28.6)	0.31 (7.9)	15000 (1034)
MPF9	1 JIC	MPF9-MTM-AN16-	2.56 (65.1)	1.37 (34.9)	0.31 (7.9)	15000 (1034)
MPF12	1/4 JIC	MPF12-MTM-AN4-	2.31 (58.7)	1.19 (30.2)	0.17 (4.4)	20000 (1379)
MPF12	3/8 JIC	MPF12-MTM-AN6-	2.31 (58.7)	1.19 (30.2)	0.23 (5.8)	20000 (1379)
MPF12	1/2 JIC	MPF12-MTM-AN8-	2.37 (60.3)	1.19 (30.2)	0.31 (7.9)	20000 (1379)
MPF12	5/8 JIC	MPF12-MTM-AN10-	2.50 (63.5)	1.19 (30.2)	0.37 (9.4)	20000 (1379)
MPF12	3/4 JIC	MPF12-MTM-AN12-	2.63 (66.7)	1.19 (30.2)	0.44 (11.1)	15000 (1034)
MPF12	1 JIC	MPF12-MTM-AN16-	2.69 (68.3)	1.37 (34.9)	0.44 (11.1)	15000 (1034)
MPF16	1/4 JIC	MPF16-MTM-AN4-	2.81 (71.4)	1.50 (38.1)	0.17 (4.4)	20000 (1379)
MPF16	3/8 JIC	MPF16-MTM-AN6-	2.81 (71.4)	1.50 (38.1)	0.23 (5.8)	20000 (1379)
MPF16	1/2 JIC	MPF16-MTM-AN8-	2.94 (74.6)	1.50 (38.1)	0.31 (7.9)	20000 (1379)
MPF16	5/8 JIC	MPF16-MTM-AN10-	3.06 (77.8)	1.50 (38.1)	0.37 (9.4)	20000 (1379)
MPF16	3/4 JIC	MPF16-MTM-AN12-	3.13 (79.4)	1.50 (38.1)	0.46 (11.6)	15000 (1034)
MPF16	1 JIC	MPF16-MTM-AN16-	3.19 (81.0)	1.50 (38.1)	0.56 (14.3)	15000 (1034)

## Medium Pressure Male to Type M hose Male

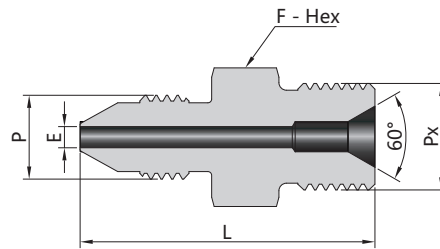

### Medium Pressure Male

### Type M hose Male

P-Connection Type	PX-Connection Type	Ordering Number	Dimension, in. (mm)			Working Pressure psig (bar)
			L	F	E	
MPF4	RH9	MPF4-MTM-RH9-	1.52 (38.7)	0.63 (15.9)	0.09 (2.4)	20000 (1379)
MPF4	RH12	MPF4-MTM-RH12-	1.69 (43.0)	0.75 (19.1)	0.11 (2.8)	20000 (1379)
MPF4	RH14	MPF4-MTM-RH14-	1.90 (48.2)	1.00 (25.4)	0.11 (2.8)	20000 (1379)
MPF4	RH16	MPF4-MTM-RH16-	1.78 (45.3)	1.00 (25.4)	0.11 (2.8)	20000 (1379)
MPF4	RH21	MPF4-MTM-RH21-	1.90 (48.3)	1.37 (34.9)	0.11 (2.8)	20000 (1379)
MPF6	RH9	MPF6-MTM-RH9-	1.67 (42.4)	0.63 (15.9)	0.09 (2.4)	20000 (1379)
MPF6	RH12	MPF6-MTM-RH12-	1.84 (46.7)	0.75 (19.1)	0.20 (5.2)	20000 (1379)
MPF6	RH14	MPF6-MTM-RH14-	2.04 (51.9)	1.00 (25.4)	0.15 (3.8)	20000 (1379)
MPF6	RH16	MPF6-MTM-RH16-	1.93 (49.0)	1.00 (25.4)	0.20 (5.2)	20000 (1379)
MPF6	RH21	MPF6-MTM-RH21-	2.05 (52.0)	1.37 (34.9)	0.20 (5.2)	20000 (1379)
MPF9	RH9	MPF9-MTM-RH9-	1.95 (49.6)	0.94 (23.8)	0.09 (2.4)	20000 (1379)
MPF9	RH12	MPF9-MTM-RH12-	2.08 (52.9)	0.94 (23.8)	0.29 (7.4)	20000 (1379)
MPF9	RH14	MPF9-MTM-RH14-	2.23 (56.7)	1.00 (25.4)	0.15 (3.8)	20000 (1379)
MPF9	RH16	MPF9-MTM-RH16-	2.12 (53.8)	1.00 (25.4)	0.31 (7.9)	20000 (1379)
MPF9	RH21	MPF9-MTM-RH21-	2.24 (56.8)	1.37 (34.9)	0.31 (7.9)	20000 (1379)
MPF12	RH9	MPF12-MTM-RH9-	2.22 (56.3)	1.19 (30.2)	0.09 (2.4)	20000 (1379)
MPF12	RH12	MPF12-MTM-RH12-	2.35 (59.6)	1.19 (30.2)	0.29 (7.4)	20000 (1379)
MPF12	RH14	MPF12-MTM-RH14-	2.47 (62.8)	1.19 (30.2)	0.15 (3.8)	20000 (1379)
MPF12	RH16	MPF12-MTM-RH16-	2.36 (59.9)	1.19 (30.2)	0.39 (10.0)	20000 (1379)
MPF12	RH21	MPF12-MTM-RH21-	2.41 (61.1)	1.37 (34.9)	0.44 (11.1)	20000 (1379)
MPF16	RH9	MPF16-MTM-RH9-	2.77 (70.3)	1.50 (38.1)	0.09 (2.4)	20000 (1379)
MPF16	RH12	MPF16-MTM-RH12-	2.90 (73.6)	1.50 (38.1)	0.29 (7.4)	20000 (1379)
MPF16	RH14	MPF16-MTM-RH14-	3.02 (76.8)	1.50 (38.1)	0.15 (3.8)	20000 (1379)
MPF16	RH16	MPF16-MTM-RH16-	2.91 (73.9)	1.50 (38.1)	0.39 (10.0)	20000 (1379)
MPF16	RH21	MPF16-MTM-RH21-	2.89 (73.3)	1.50 (38.1)	0.56 (14.3)	20000 (1379)

## High Pressure Male to Low Pressure Male

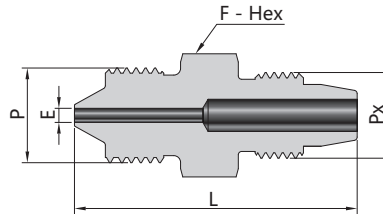

### High Pressure Male

### Low Pressure Male

P-Connection Type	PX-Connection Type	Ordering Number	Dimension, in. (mm)			Working Pressure psig (bar)
			L	F	E	
HPF4	LPF2	HPF4-MTM-LPF2-	1.50 (38.1)	0.63 (15.9)	0.08 (2.1)	15000 (1034)
HPF4	LPF4	HPF4-MTM-LPF4-	1.69 (42.9)	0.63 (15.9)	0.08 (2.1)	15000 (1034)
HPF4	LPF6	HPF4-MTM-LPF6-	1.75 (44.5)	0.75 (19.1)	0.08 (2.1)	15000 (1034)
HPF4	LPF8	HPF4-MTM-LPF8-	1.87 (47.6)	0.94 (23.8)	0.08 (2.1)	15000 (1034)
HPF6	LPF2	HPF6-MTM-LPF2-	1.81 (46.0)	0.81 (20.6)	0.09 (2.4)	15000 (1034)
HPF6	LPF4	HPF6-MTM-LPF4-	2.00 (50.8)	0.81 (20.6)	0.13 (3.2)	15000 (1034)
HPF6	LPF6	HPF6-MTM-LPF6-	2.06 (52.4)	0.81 (20.6)	0.13 (3.2)	15000 (1034)
HPF6	LPF8	HPF6-MTM-LPF8-	2.13 (54.0)	0.94 (23.8)	0.13 (3.2)	15000 (1034)
HPF9	LPF2	HPF9-MTM-LPF2-	2.13 (54.0)	1.19 (30.2)	0.09 (2.4)	15000 (1034)
HPF9	LPF4	HPF9-MTM-LPF4-	2.31 (58.7)	1.19 (30.2)	0.19 (4.8)	15000 (1034)
HPF9	LPF6	HPF9-MTM-LPF6-	2.31 (58.7)	1.19 (30.2)	0.19 (4.8)	15000 (1034)
HPF9	LPF8	HPF9-MTM-LPF8-	2.37 (60.3)	1.19 (30.2)	0.19 (4.8)	15000 (1034)

## High Pressure Male to Medium Pressure Male

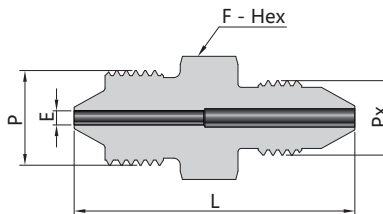

### High Pressure Male

### Medium Pressure Male

P-Connection Type	PX-Connection Type	Ordering Number	Dimension, in. (mm)			Working Pressure psig (bar)
			L	F	E	
HPF4	MPF4	HPF4-MTM-MPF4-	1.69 (42.9)	0.63 (15.9)	0.08 (2.1)	20000 (1379)
HPF4	MPF6	HPF4-MTM-MPF6-	1.81 (46.0)	0.63 (15.9)	0.08 (2.1)	20000 (1379)
HPF4	MPF9	HPF4-MTM-MPF9-	2.06 (52.4)	0.94 (23.8)	0.08 (2.1)	20000 (1379)
HPF4	MPF12	HPF4-MTM-MPF12-	2.37 (60.3)	1.19 (30.2)	0.08 (2.1)	20000 (1379)
HPF4	MPF16	HPF4-MTM-MPF16-	2.94 (74.6)	1.50 (38.1)	0.08 (2.1)	20000 (1379)
HPF6	MPF4	HPF6-MTM-MPF4-	2.00 (50.8)	0.81 (20.6)	0.11 (2.8)	20000 (1379)
HPF6	MPF6	HPF6-MTM-MPF6-	2.13 (54.0)	0.81 (20.6)	0.13 (3.2)	20000 (1379)
HPF6	MPF9	HPF6-MTM-MPF9-	2.37 (60.3)	0.94 (23.8)	0.13 (3.2)	20000 (1379)
HPF6	MPF12	HPF6-MTM-MPF12-	2.63 (66.7)	1.19 (30.2)	0.13 (3.2)	20000 (1379)
HPF6	MPF16	HPF6-MTM-MPF16-	3.13 (79.4)	1.50 (38.1)	0.13 (3.2)	20000 (1379)
HPF9	MPF4	HPF9-MTM-MPF4-	2.25 (57.2)	1.19 (30.2)	0.11 (2.8)	20000 (1379)
HPF9	MPF6	HPF9-MTM-MPF6-	2.44 (61.9)	1.19 (30.2)	0.19 (4.8)	20000 (1379)
HPF9	MPF9	HPF9-MTM-MPF9-	2.63 (66.7)	1.19 (30.2)	0.19 (4.8)	20000 (1379)
HPF9	MPF12	HPF9-MTM-MPF12-	2.80 (71.0)	1.19 (30.2)	0.19 (4.8)	20000 (1379)
HPF9	MPF16	HPF9-MTM-MPF16-	3.31 (84.2)	1.50 (38.1)	0.19 (4.8)	20000 (1379)

## High Pressure Male to High Pressure Male

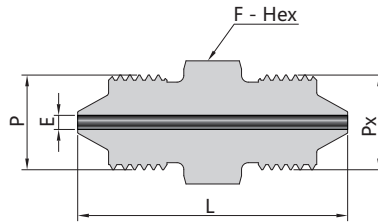

High Pressure Male

High Pressure Male

P-Connection Type	PX-Connection Type	Ordering Number	Dimension, in. (mm)			Working Pressure psig (bar)
			L	F	E	
HPF4	HPF4	HPF4-MTM-HPF4-	1.63 (41.3)	0.63 (15.9)	0.08 (2.1)	60000 (4137)
HPF6	HPF4	HPF6-MTM-HPF4-	1.94 (49.2)	0.81 (20.6)	0.08 (2.1)	60000 (4137)
HPF6	HPF6	HPF6-MTM-HPF6-	2.19 (55.6)	0.81 (20.6)	0.13 (3.2)	60000 (4137)
HPF9	HPF4	HPF9-MTM-HPF4-	2.19 (55.6)	1.19 (30.2)	0.08 (2.1)	60000 (4137)
HPF9	HPF6	HPF9-MTM-HPF6-	2.50 (63.5)	1.19 (30.2)	0.13 (3.2)	60000 (4137)
HPF9	HPF9	HPF9-MTM-HPF9-	2.63 (66.7)	1.19 (30.2)	0.19 (4.8)	60000 (4137)

## High Pressure Male to Male NPT Threads

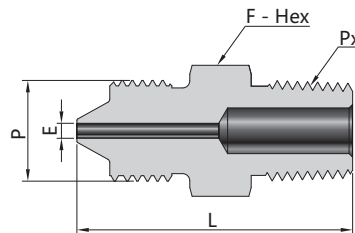

High Pressure Male

Male NPT Threads

P-Connection Type	PX-Connection Type	Ordering Number	Dimension, in. (mm)			Working Pressure psig (bar)
			L	F	E	
HPF4	1/8 NPT	HPF4-MTM-NPT2-	1.37 (34.9)	0.63 (15.9)	0.08 (2.1)	15000 (1034)
HPF4	1/4 NPT	HPF4-MTM-NPT4-	1.56 (39.7)	0.63 (15.9)	0.08 (2.1)	15000 (1034)
HPF4	3/8 NPT	HPF4-MTM-NPT6-	1.56 (39.7)	0.69 (17.5)	0.08 (2.1)	15000 (1034)
HPF4	1/2 NPT	HPF4-MTM-NPT8-	1.81 (46.0)	0.87 (22.2)	0.08 (2.1)	15000 (1034)
HPF4	3/4 NPT	HPF4-MTM-NPT12-	1.87 (47.6)	1.06 (27.0)	0.08 (2.1)	10000 (690)
HPF4	1 NPT	HPF4-MTM-NPT16-	2.19 (55.6)	1.37 (34.9)	0.08 (2.1)	10000 (690)
HPF6	1/8 NPT	HPF6-MTM-NPT2-	1.69 (42.9)	0.81 (20.6)	0.13 (3.2)	15000 (1034)
HPF6	1/4 NPT	HPF6-MTM-NPT4-	1.87 (47.6)	0.81 (20.6)	0.13 (3.2)	15000 (1034)
HPF6	3/8 NPT	HPF6-MTM-NPT6-	1.87 (47.6)	0.81 (20.6)	0.13 (3.2)	15000 (1034)
HPF6	1/2 NPT	HPF6-MTM-NPT8-	2.06 (52.4)	0.87 (22.2)	0.13 (3.2)	15000 (1034)
HPF6	3/4 NPT	HPF6-MTM-NPT12-	2.13 (54.0)	1.06 (27.0)	0.13 (3.2)	10000 (690)
HPF6	1 NPT	HPF6-MTM-NPT16-	2.44 (61.9)	1.37 (34.9)	0.13 (3.2)	10000 (690)
HPF9	1/8 NPT	HPF9-MTM-NPT2-	2.00 (50.8)	1.19 (30.2)	0.19 (4.8)	15000 (1034)
HPF9	1/4 NPT	HPF9-MTM-NPT4-	2.13 (54.0)	1.19 (30.2)	0.19 (4.8)	15000 (1034)
HPF9	3/8 NPT	HPF9-MTM-NPT6-	2.13 (54.0)	1.19 (30.2)	0.19 (4.8)	15000 (1034)
HPF9	1/2 NPT	HPF9-MTM-NPT8-	2.37 (60.3)	1.19 (30.2)	0.19 (4.8)	15000 (1034)
HPF9	3/4 NPT	HPF9-MTM-NPT12-	2.37 (60.3)	1.19 (30.2)	0.19 (4.8)	10000 (690)
HPF9	1 NPT	HPF9-MTM-NPT16-	2.63 (66.7)	1.37 (34.9)	0.19 (4.8)	10000 (690)

## High Pressure Male to Male JIC

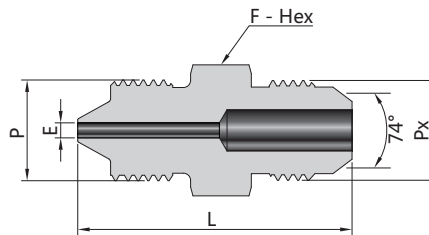

### High Pressure Male

### Male JIC

P-Connection Type	PX-Connection Type	Ordering Number	Dimension, in. (mm)			Working Pressure psig (bar)
			L	F	E	
HPF4	1/4 JIC	HPF4-MTM-AN4-	1.56 (39.7)	0.63 (15.9)	0.08 (2.1)	20000 (1379)
HPF4	3/8 JIC	HPF4-MTM-AN6-	1.56 (39.7)	0.63 (15.9)	0.08 (2.1)	20000 (1379)
HPF4	1/2 JIC	HPF4-MTM-AN8-	1.69 (42.9)	0.81 (20.6)	0.08 (2.1)	20000 (1379)
HPF4	5/8 JIC	HPF4-MTM-AN10-	1.81 (46.0)	0.94 (23.8)	0.08 (2.1)	20000 (1379)
HPF4	3/4 JIC	HPF4-MTM-AN12-	2.00 (50.8)	1.13 (28.6)	0.08 (2.1)	15000 (1034)
HPF4	1 JIC	HPF4-MTM-AN16-	2.13 (54.0)	1.37 (34.9)	0.08 (2.1)	15000 (1034)
HPF6	1/4 JIC	HPF6-MTM-AN4-	1.81 (46.0)	0.81 (20.6)	0.13 (3.2)	20000 (1379)
HPF6	3/8 JIC	HPF6-MTM-AN6-	1.81 (46.0)	0.81 (20.6)	0.13 (3.2)	20000 (1379)
HPF6	1/2 JIC	HPF6-MTM-AN8-	1.94 (49.2)	0.81 (20.6)	0.13 (3.2)	20000 (1379)
HPF6	5/8 JIC	HPF6-MTM-AN10-	2.06 (52.4)	0.94 (23.8)	0.13 (3.2)	20000 (1379)
HPF6	3/4 JIC	HPF6-MTM-AN12-	2.25 (57.2)	1.13 (28.6)	0.13 (3.2)	15000 (1034)
HPF6	1 JIC	HPF6-MTM-AN16-	2.37 (60.3)	1.37 (34.9)	0.13 (3.2)	15000 (1034)
HPF9	1/4 JIC	HPF9-MTM-AN4-	2.13 (54.0)	1.19 (30.2)	0.17 (4.4)	20000 (1379)
HPF9	3/8 JIC	HPF9-MTM-AN6-	2.13 (54.0)	1.19 (30.2)	0.19 (4.8)	20000 (1379)
HPF9	1/2 JIC	HPF9-MTM-AN8-	2.25 (57.2)	1.19 (30.2)	0.19 (4.8)	20000 (1379)
HPF9	5/8 JIC	HPF9-MTM-AN10-	2.37 (60.3)	1.19 (30.2)	0.19 (4.8)	20000 (1379)
HPF9	3/4 JIC	HPF9-MTM-AN12-	2.44 (61.9)	1.19 (30.2)	0.19 (4.8)	15000 (1034)
HPF9	1 JIC	HPF9-MTM-AN16-	2.56 (65.0)	1.37 (34.9)	0.19 (4.8)	15000 (1034)

## High Pressure Male to Type M hose Male

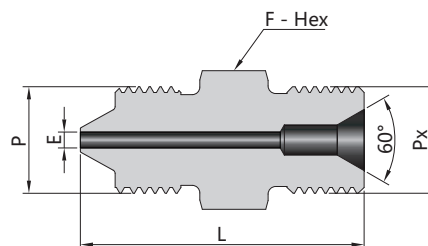

### High Pressure Male

### Type M hose Male

P-Connection Type	PX-Connection Type	Ordering Number	Dimension, in. (mm)			Working Pressure psig (bar)
			L	F	E	
HPF4	RH9	HPF4-MTM-RH9-	1.46 (37.1)	0.63 (15.9)	0.08 (2.1)	30000 (2068)
HPF4	RH12	HPF4-MTM-RH12-	1.63 (41.4)	0.75 (19.1)	0.08 (2.1)	30000 (2068)
HPF4	RH14	HPF4-MTM-RH14-	1.83 (46.6)	1.00 (25.4)	0.08 (2.1)	30000 (2068)
HPF4	RH16	HPF4-MTM-RH16-	1.72 (43.7)	1.00 (25.4)	0.08 (2.1)	20000 (1379)
HPF4	RH21	HPF4-MTM-RH21-	1.84 (46.7)	1.37 (34.9)	0.08 (2.1)	20000 (1379)
HPF6	RH9	HPF6-MTM-RH9-	1.77 (44.9)	0.81 (20.6)	0.09 (2.4)	30000 (2068)
HPF6	RH12	HPF6-MTM-RH12-	1.90 (48.2)	0.81 (20.6)	0.13 (3.2)	30000 (2068)

**High Pressure Male**

**Type M hose Male**

P-Connection Type	PX-Connection Type	Ordering Number	Dimension, in. (mm)			Working Pressure psig (bar)
			L	F	E	
HPF6	RH14	HPF6-MTM-RH14-	2.09 (53.0)	1.00 (25.4)	0.13 (3.2)	30000 (2068)
HPF6	RH16	HPF6-MTM-RH16-	1.97 (50.1)	1.00 (25.4)	0.13 (3.2)	20000 (1379)
HPF6	RH21	HPF6-MTM-RH21-	2.09 (53.1)	1.37 (34.9)	0.13 (3.2)	20000 (1379)
HPF9	RH9	HPF9-MTM-RH9-	2.07 (52.6)	1.19 (30.2)	0.09 (2.4)	30000 (2068)
HPF9	RH12	HPF9-MTM-RH12-	2.20 (55.9)	1.19 (30.2)	0.19 (4.8)	30000 (2068)
HPF9	RH14	HPF9-MTM-RH14-	2.33 (59.1)	1.19 (30.2)	0.15 (3.8)	30000 (2068)
HPF9	RH16	HPF9-MTM-RH16-	2.21 (56.2)	1.19 (30.2)	0.19 (4.8)	20000 (1379)
HPF9	RH21	HPF9-MTM-RH21-	2.26 (57.4)	1.37 (34.9)	0.19 (4.8)	20000 (1379)

**Medium Pressure Female to Low Pressure Female**

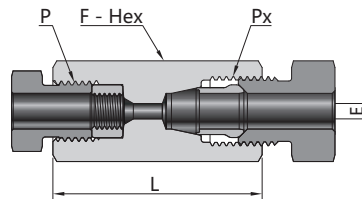

**Medium Pressure Female**

**Low Pressure Female**

P-Connection Type	PX-Connection Type	Ordering Number	Dimension, in. (mm)			Working Pressure psig (bar)
			L	F	E	
MPF4	LPF2	MPF4-FTF-LPF2-	1.25 (31.8)	0.63 (15.9)	0.09 (2.4)	15000 (1034)
MPF4	LPF4	MPF4-FTF-LPF4-	1.50 (38.1)	0.63 (15.9)	0.11 (2.8)	15000 (1034)
MPF4	LPF6	MPF4-FTF-LPF6-	1.63 (41.3)	0.75 (19.1)	0.11 (2.8)	15000 (1034)
MPF4	LPF8	MPF4-FTF-LPF8-	1.75 (44.5)	1.00 (25.4)	0.11 (2.8)	15000 (1034)
MPF6	LPF2	MPF6-FTF-LPF2-	1.44 (36.5)	0.75 (19.1)	0.09 (2.4)	15000 (1034)
MPF6	LPF4	MPF6-FTF-LPF4-	1.69 (42.9)	0.75 (19.1)	0.19 (4.8)	15000 (1034)
MPF6	LPF6	MPF6-FTF-LPF6-	1.75 (44.5)	0.75 (19.1)	0.20 (5.2)	15000 (1034)
MPF6	LPF8	MPF6-FTF-LPF8-	1.87 (47.6)	1.00 (25.4)	0.20 (5.2)	15000 (1034)
MPF9	LPF2	MPF9-FTF-LPF2-	1.69 (42.9)	1.00 (25.4)	0.09 (2.4)	15000 (1034)
MPF9	LPF4	MPF9-FTF-LPF4-	1.87 (47.6)	1.00 (25.4)	0.19 (4.8)	15000 (1034)
MPF9	LPF6	MPF9-FTF-LPF6-	1.94 (49.2)	1.00 (25.4)	0.25 (6.4)	15000 (1034)
MPF9	LPF8	MPF9-FTF-LPF8-	2.06 (52.4)	1.00 (25.4)	0.31 (7.9)	15000 (1034)
MPF12	LPF6	MPF12-FTF-LPF6-	2.25 (57.2)	1.37 (34.9)	0.25 (6.4)	15000 (1034)
MPF12	LPF8	MPF12-FTF-LPF8-	2.25 (57.2)	1.37 (34.9)	0.37 (9.5)	15000 (1034)
MPF16	LPF8	MPF16-FTF-LPF8-	2.81 (71.4)	1.75 (44.5)	0.37 (9.5)	15000 (1034)

## Medium Pressure Female to Female NPT Thread

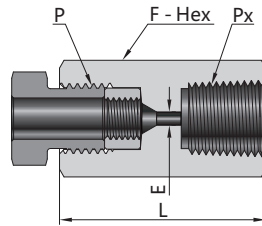

### Medium Pressure Female

### Female NPT Threads

P-Connection Type	PX-Connection Type	Ordering Number	Dimension, in. (mm)			Working Pressure psig (bar)
			L	F	E	
MPF4	1/8 Female NPT	MPF4-FTF-FNPT2-	1.37 (34.9)	0.63 (15.9)	0.11 (2.8)	15000 (1034)
MPF4	1/4 Female NPT	MPF4-FTF-FNPT4-	1.63 (41.3)	0.94 (23.8)	0.11 (2.8)	15000 (1034)
MPF4	3/8 Female NPT	MPF4-FTF-FNPT6-	1.63 (41.3)	1.13 (28.6)	0.11 (2.8)	15000 (1034)
MPF4	1/2 Female NPT	MPF4-FTF-FNPT8-	2.00 (50.8)	1.37 (34.9)	0.11 (2.8)	15000 (1034)
MPF6	1/8 Female NPT	MPF6-FTF-FNPT2-	1.50 (38.1)	0.75 (19.1)	0.20 (5.1)	15000 (1034)
MPF6	1/4 Female NPT	MPF6-FTF-FNPT4-	1.75 (44.5)	0.94 (23.8)	0.20 (5.1)	15000 (1034)
MPF6	3/8 Female NPT	MPF6-FTF-FNPT6-	1.81 (46.0)	1.13 (28.6)	0.20 (5.1)	15000 (1034)
MPF6	1/2 Female NPT	MPF6-FTF-FNPT8-	2.13 (54.0)	1.37 (34.9)	0.20 (5.1)	15000 (1034)
MPF6	3/4 Female NPT	MPF6-FTF-FNPT12-	2.25 (57.2)	1.50 (38.1)	0.20 (5.1)	10000 (690)
MPF9	1/8 Female NPT	MPF9-FTF-FNPT2-	1.63 (41.3)	1.00 (25.4)	0.31 (7.9)	15000 (1034)
MPF9	1/4 Female NPT	MPF9-FTF-FNPT4-	2.00 (50.8)	1.00 (25.4)	0.31 (7.9)	15000 (1034)
MPF9	3/8 Female NPT	MPF9-FTF-FNPT6-	2.00 (50.8)	1.13 (28.6)	0.31 (7.9)	15000 (1034)
MPF9	1/2 Female NPT	MPF9-FTF-FNPT8-	2.25 (57.2)	1.37 (34.9)	0.31 (7.9)	15000 (1034)
MPF9	3/4 Female NPT	MPF9-FTF-FNPT12-	2.25 (57.2)	1.50 (38.1)	0.31 (7.9)	10000 (690)
MPF9	1 Female NPT	MPF9-FTF-FNPT16-	2.63 (66.7)	1.75 (44.5)	0.31 (7.9)	10000 (690)
MPF12	1/8 Female NPT	MPF12-FTF-FNPT2-	1.75 (44.5)	1.37 (34.9)	0.32 (8.1)	15000 (1034)
MPF12	1/4 Female NPT	MPF12-FTF-FNPT4-	2.00 (50.8)	1.37 (34.9)	0.41 (10.4)	15000 (1034)
MPF12	3/8 Female NPT	MPF12-FTF-FNPT6-	2.37 (60.3)	1.37 (34.9)	0.44 (11.1)	15000 (1034)
MPF12	1/2 Female NPT	MPF12-FTF-FNPT8-	2.63 (66.7)	1.37 (34.9)	0.44 (11.1)	15000 (1034)
MPF12	3/4 Female NPT	MPF12-FTF-FNPT12-	2.63 (66.7)	1.50 (38.1)	0.44 (11.1)	10000 (690)
MPF12	1 Female NPT	MPF12-FTF-FNPT16-	2.63 (66.7)	1.75 (44.5)	0.44 (11.1)	10000 (690)
MPF16	1/4 Female NPT	MPF16-FTF-FNPT4-	2.37 (60.3)	1.75 (44.5)	0.41 (10.4)	15000 (1034)
MPF16	3/8 Female NPT	MPF16-FTF-FNPT6-	2.50 (63.5)	1.75 (44.5)	0.55 (13.9)	15000 (1034)
MPF16	1/2 Female NPT	MPF16-FTF-FNPT8-	3.00 (76.2)	1.75 (44.5)	0.56 (14.3)	15000 (1034)
MPF16	3/4 Female NPT	MPF16-FTF-FNPT12-	3.00 (76.2)	1.75 (44.5)	0.56 (14.3)	10000 (690)
MPF16	1 Female NPT	MPF16-FTF-FNPT16-	3.00 (76.2)	1.75 (44.5)	0.56 (14.3)	10000 (690)

## High Pressure Female to Low Pressure Female

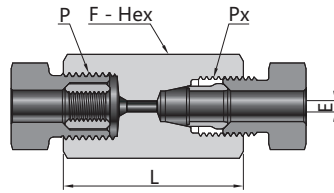

### High Pressure Female

### Low Pressure Female

P-Connection Type	PX-Connection Type	Ordering Number	Dimension, in. (mm)			Working Pressure psig (bar)
			L	F	E	
HPF4	LPF2	HPF4-FTF-LPF2-	1.19 (30.2)	0.75 (19.1)	0.09 (2.4)	15000 (1034)
HPF4	LPF4	HPF4-FTF-LPF4-	1.50 (38.1)	0.75 (19.1)	0.09 (2.4)	15000 (1034)
HPF4	LPF6	HPF4-FTF-LPF6-	1.63 (41.3)	0.75 (19.1)	0.09 (2.4)	15000 (1034)
HPF4	LPF8	HPF4-FTF-LPF8-	1.75 (44.5)	1.00 (25.4)	0.09 (2.4)	15000 (1034)
HPF6	LPF2	HPF6-FTF-LPF2-	1.50 (38.1)	1.00 (25.4)	0.09 (2.4)	15000 (1034)
HPF6	LPF4	HPF6-FTF-LPF4-	1.75 (44.5)	1.00 (25.4)	0.13 (3.2)	15000 (1034)
HPF6	LPF6	HPF6-FTF-LPF6-	1.81 (46.0)	1.00 (25.4)	0.13 (3.2)	15000 (1034)
HPF6	LPF8	HPF6-FTF-LPF8-	2.00 (50.8)	1.00 (25.4)	0.13 (3.2)	15000 (1034)
HPF9	LPF2	HPF9-FTF-LPF2-	1.69 (42.9)	1.37 (34.9)	0.09 (2.4)	15000 (1034)
HPF9	LPF4	HPF9-FTF-LPF4-	1.87 (47.6)	1.37 (34.9)	0.19 (4.8)	15000 (1034)
HPF9	LPF6	HPF9-FTF-LPF6-	2.00 (50.8)	1.37 (34.9)	0.19 (4.8)	15000 (1034)
HPF9	LPF8	HPF9-FTF-LPF8-	2.13 (54.0)	1.37 (34.9)	0.19 (4.8)	15000 (1034)

## 60 Series Female to 20 Series Female

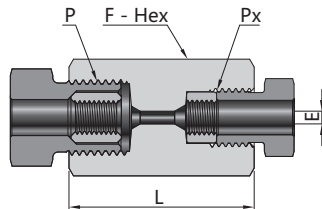

### High Pressure Female

### Medium Pressure Female

P-Connection Type	PX-Connection Type	Ordering Number	Dimension, in. (mm)			Working Pressure psig (bar)
			L	F	E	
HPF4	MPF4	HPF4-FTF-MPF4-	1.37 (34.9)	0.75 (19.1)	0.09 (2.4)	20000 (1379)
HPF4	MPF6	HPF4-FTF-MPF6-	1.56 (39.7)	0.75 (19.1)	0.09 (2.4)	20000 (1379)
HPF4	MPF9	HPF4-FTF-MPF9-	1.81 (46.0)	1.00 (25.4)	0.09 (2.4)	20000 (1379)
HPF4	MPF12	HPF4-FTF-MPF12-	2.06 (52.4)	1.37 (34.9)	0.09 (2.4)	20000 (1379)
HPF4	MPF16	HPF4-FTF-MPF16-	2.56 (65.1)	1.75 (44.5)	0.09 (2.4)	20000 (1379)
HPF6	MPF4	HPF6-FTF-MPF4-	1.63 (41.3)	1.00 (25.4)	0.11 (2.8)	20000 (1379)
HPF6	MPF6	HPF6-FTF-MPF6-	1.81 (46.0)	1.00 (25.4)	0.13 (3.2)	20000 (1379)
HPF6	MPF9	HPF6-FTF-MPF9-	2.06 (52.4)	1.00 (25.4)	0.13 (3.2)	20000 (1379)
HPF6	MPF12	HPF6-FTF-MPF12-	2.31 (58.7)	1.37 (34.9)	0.13 (3.2)	20000 (1379)
HPF6	MPF16	HPF6-FTF-MPF16-	2.81 (71.4)	1.75 (44.5)	0.13 (3.2)	20000 (1379)
HPF9	MPF4	HPF9-FTF-MPF4-	1.81 (46.0)	1.37 (34.9)	0.11 (2.8)	20000 (1379)
HPF9	MPF6	HPF9-FTF-MPF6-	1.94 (49.2)	1.37 (34.9)	0.19 (4.8)	20000 (1379)
HPF9	MPF9	HPF9-FTF-MPF9-	2.25 (57.2)	1.37 (34.9)	0.19 (4.8)	20000 (1379)
HPF9	MPF12	HPF9-FTF-MPF12-	2.44 (61.9)	1.37 (34.9)	0.19 (4.8)	20000 (1379)
HPF9	MPF16	HPF9-FTF-MPF16-	3.00 (76.2)	1.75 (44.5)	0.19 (4.8)	20000 (1379)



## High Pressure Female to Female NPT Thread

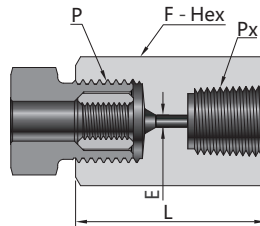

### High Pressure Female

### Female NPT Threads

P-Connection Type	PX-Connection Type	Ordering Number	Dimension, in. (mm)			Working Pressure psig (bar)
			L	F	E	
HPF4	1/8 Female NPT	HPF4-FTF-FNPT2-	1.37 (34.9)	0.75 (19.1)	0.09 (2.4)	15000 (1034)
HPF4	1/4 Female NPT	HPF4-FTF-FNPT4-	1.63 (41.3)	0.94 (23.8)	0.09 (2.4)	15000 (1034)
HPF4	3/8 Female NPT	HPF4-FTF-FNPT6-	1.63 (41.3)	1.13 (28.6)	0.09 (2.4)	15000 (1034)
HPF4	1/2 Female NPT	HPF4-FTF-FNPT8-	2.00 (50.8)	1.37 (34.9)	0.09 (2.4)	15000 (1034)
HPF4	3/4 Female NPT	HPF4-FTF-FNPT12-	2.00 (50.8)	1.50 (38.1)	0.09 (2.4)	10000 (690)
HPF4	1 Female NPT	HPF4-FTF-FNPT16-	2.37 (60.3)	1.75 (44.5)	0.09 (2.4)	10000 (690)
HPF6	1/8 Female NPT	HPF6-FTF-FNPT2-	1.63 (41.3)	1.00 (25.4)	0.13 (3.2)	15000 (1034)
HPF6	1/4 Female NPT	HPF6-FTF-FNPT4-	1.87 (47.6)	1.00 (25.4)	0.13 (3.2)	15000 (1034)
HPF6	3/8 Female NPT	HPF6-FTF-FNPT6-	1.87 (47.6)	1.13 (28.6)	0.13 (3.2)	15000 (1034)
HPF6	1/2 Female NPT	HPF6-FTF-FNPT8-	2.13 (54.0)	1.37 (34.9)	0.13 (3.2)	15000 (1034)
HPF6	3/4 Female NPT	HPF6-FTF-FNPT12-	2.13 (54.0)	1.50 (38.1)	0.13 (3.2)	10000 (690)
HPF6	1 Female NPT	HPF6-FTF-FNPT16-	2.25 (57.2)	1.75 (44.5)	0.13 (3.2)	10000 (690)
HPF9	1/8 Female NPT	HPF9-FTF-FNPT2-	1.81 (46.0)	1.37 (34.9)	0.19 (4.8)	15000 (1034)
HPF9	1/4 Female NPT	HPF9-FTF-FNPT4-	2.00 (50.8)	1.37 (34.9)	0.19 (4.8)	15000 (1034)
HPF9	3/8 Female NPT	HPF9-FTF-FNPT6-	2.00 (50.8)	1.37 (34.9)	0.19 (4.8)	15000 (1034)
HPF9	1/2 Female NPT	HPF9-FTF-FNPT8-	2.37 (60.3)	1.37 (34.9)	0.19 (4.8)	15000 (1034)
HPF9	3/4 Female NPT	HPF9-FTF-FNPT12-	2.37 (60.3)	1.50 (38.1)	0.19 (4.8)	10000 (690)
HPF9	1 Female NPT	HPF9-FTF-FNPT16-	2.50 (63.5)	1.75 (44.5)	0.19 (4.8)	10000 (690)

## Low Pressure Female to Low Pressure Male

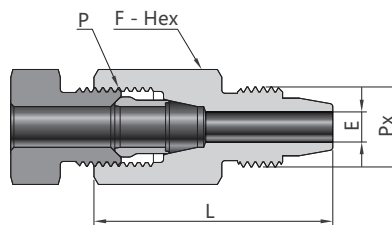

### Low Pressure Female

### Low Pressure Male

P Connection Type	PX-Connection Type	Ordering Number	Dimension, in. (mm)			Working Pressure psig (bar)
			L	F	E	
LPF2	LPF2	LPF2-FTM-LPF2-	1.06 (27.0)	0.50 (12.7)	0.09 (2.4)	15000 (1034)
LPF2	LPF4	LPF2-FTM-LPF4-	1.13 (28.6)	0.63 (15.9)	0.09 (2.4)	15000 (1034)
LPF2	LPF6	LPF2-FTM-LPF6-	1.13 (28.6)	0.75 (19.1)	0.09 (2.4)	15000 (1034)
LPF2	LPF8	LPF2-FTM-LPF8-	1.31 (33.3)	0.94 (23.8)	0.09 (2.4)	15000 (1034)

Low Pressure Female

Low Pressure Male

P-Connection Type	PX-Connection Type	Ordering Number	Dimension, in. (mm)			Working Pressure psig (bar)
			L	F	E	
LPF4	LPF2	LPF4-FTM-LPF2-	1.44 (36.5)	0.63 (15.9)	0.09 (2.4)	15000 (1034)
LPF4	LPF4	LPF4-FTM-LPF4-	1.50 (38.1)	0.63 (15.9)	0.19 (4.8)	15000 (1034)
LPF4	LPF6	LPF4-FTM-LPF6-	1.50 (38.1)	0.75 (19.1)	0.19 (4.8)	15000 (1034)
LPF4	LPF8	LPF4-FTM-LPF8-	1.50 (38.1)	0.94 (23.8)	0.19 (4.8)	15000 (1034)
LPF6	LPF2	LPF6-FTM-LPF2-	1.56 (39.7)	0.75 (19.1)	0.09 (2.4)	15000 (1034)
LPF6	LPF4	LPF6-FTM-LPF4-	1.69 (42.9)	0.75 (19.1)	0.19 (4.8)	15000 (1034)
LPF6	LPF6	LPF6-FTM-LPF6-	1.69 (42.9)	0.75 (19.1)	0.25 (6.4)	15000 (1034)
LPF6	LPF8	LPF6-FTM-LPF8-	1.63 (41.3)	0.94 (23.8)	0.25 (6.4)	15000 (1034)
LPF8	LPF2	LPF8-FTM-LPF2-	1.63 (41.3)	1.00 (25.4)	0.09 (2.4)	15000 (1034)
LPF8	LPF4	LPF8-FTM-LPF4-	1.75 (44.5)	1.00 (25.4)	0.19 (4.8)	15000 (1034)
LPF8	LPF6	LPF8-FTM-LPF6-	1.81 (46.0)	1.00 (25.4)	0.25 (6.4)	15000 (1034)
LPF8	LPF8	LPF8-FTM-LPF8-	1.81 (46.0)	1.00 (25.4)	0.37 (9.5)	15000 (1034)

Low Pressure Female to Medium Pressure Male

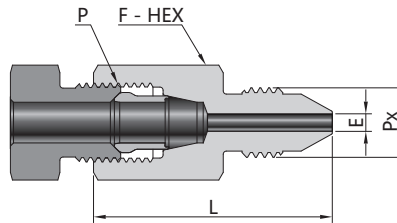

Low Pressure Female

Medium Pressure Male

P-Connection Type	PX-Connection Type	Ordering Number	Dimension, in. (mm)			Working Pressure psig (bar)
			L	F	E	
LPF2	MPF4	LPF2-FTM-MPF4-	1.19 (30.2)	0.50 (12.7)	0.09 (2.4)	15000 (1034)
LPF2	MPF6	LPF2-FTM-MPF6-	1.25 (31.8)	0.63 (15.9)	0.09 (2.4)	15000 (1034)
LPF2	MPF9	LPF2-FTM-MPF9-	1.50 (38.1)	0.94 (23.8)	0.09 (2.4)	15000 (1034)
LPF2	MPF12	LPF2-FTM-MPF12-	1.75 (44.5)	1.19 (30.2)	0.09 (2.4)	15000 (1034)
LPF2	MPF16	LPF2-FTM-MPF16-	2.37 (60.3)	1.50 (38.1)	0.09 (2.4)	15000 (1034)
LPF4	MPF4	LPF4-FTM-MPF4-	1.50 (38.1)	0.63 (15.9)	0.11 (2.8)	15000 (1034)
LPF4	MPF6	LPF4-FTM-MPF6-	1.63 (41.3)	0.63 (15.9)	0.19 (4.8)	15000 (1034)
LPF4	MPF9	LPF4-FTM-MPF9-	1.56 (39.7)	0.94 (23.8)	0.19 (4.8)	15000 (1034)
LPF4	MPF12	LPF4-FTM-MPF12-	1.75 (44.5)	1.19 (30.2)	0.19 (4.8)	15000 (1034)
LPF4	MPF16	LPF4-FTM-MPF16-	2.37 (60.3)	1.50 (38.1)	0.19 (4.8)	15000 (1034)
LPF6	MPF4	LPF6-FTM-MPF4-	1.69 (42.9)	0.75 (19.1)	0.11 (2.8)	15000 (1034)
LPF6	MPF6	LPF6-FTM-MPF6-	1.75 (44.5)	0.75 (19.1)	0.20 (5.2)	15000 (1034)
LPF6	MPF9	LPF6-FTM-MPF9-	1.81 (46.0)	0.94 (23.8)	0.25 (6.4)	15000 (1034)
LPF6	MPF12	LPF6-FTM-MPF12-	1.87 (47.6)	1.19 (30.2)	0.25 (6.4)	15000 (1034)
LPF6	MPF16	LPF6-FTM-MPF16-	2.37 (60.3)	1.50 (38.1)	0.25 (6.4)	15000 (1034)
LPF8	MPF4	LPF8-FTM-MPF4-	1.75 (44.5)	1.00 (25.4)	0.11 (2.8)	15000 (1034)
LPF8	MPF6	LPF8-FTM-MPF6-	1.94 (49.2)	1.00 (25.4)	0.20 (5.2)	15000 (1034)
LPF8	MPF9	LPF8-FTM-MPF9-	2.06 (52.4)	1.00 (25.4)	0.31 (7.9)	15000 (1034)
LPF8	MPF12	LPF8-FTM-MPF12-	2.06 (52.4)	1.19 (30.2)	0.37 (9.5)	15000 (1034)
LPF8	MPF16	LPF8-FTM-MPF16-	2.50 (63.5)	1.50 (38.1)	0.37 (9.5)	15000 (1034)

## Low Pressure Female to High Pressure Male

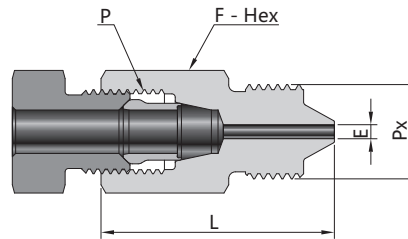

Low Pressure Female

High Pressure Male

P-Connection Type	PX-Connection Type	Ordering Number	Dimension, in. (mm)			Working Pressure psig (bar)
			L	F	E	
LPF2	HPF4	LPF2-FTM-HPF4-	1.06 (27.0)	0.63 (15.9)	0.08 (2.1)	15000 (1034)
LPF2	HPF6	LPF2-FTM-HPF6-	1.31 (33.3)	0.81 (20.6)	0.09 (2.4)	15000 (1034)
LPF2	HPF9	LPF2-FTM-HPF9-	1.63 (41.3)	1.19 (30.2)	0.09 (2.4)	15000 (1034)
LPF4	HPF4	LPF4-FTM-HPF4-	1.37 (34.9)	0.63 (15.9)	0.08 (2.1)	15000 (1034)
LPF4	HPF6	LPF4-FTM-HPF6-	1.56 (39.7)	0.81 (20.6)	0.13 (3.2)	15000 (1034)
LPF4	HPF9	LPF4-FTM-HPF9-	1.63 (41.3)	1.19 (30.2)	0.19 (4.8)	15000 (1034)
LPF6	HPF4	LPF6-FTM-HPF4-	1.56 (39.7)	0.75 (19.1)	0.08 (2.1)	15000 (1034)
LPF6	HPF6	LPF6-FTM-HPF6-	1.75 (44.5)	0.81 (20.6)	0.13 (3.2)	15000 (1034)
LPF6	HPF9	LPF6-FTM-HPF9-	1.63 (41.3)	1.19 (30.2)	0.19 (4.8)	15000 (1034)
LPF8	HPF4	LPF8-FTM-HPF4-	1.69 (42.9)	1.00 (25.4)	0.08 (2.1)	15000 (1034)
LPF8	HPF6	LPF8-FTM-HPF6-	1.87 (47.6)	1.00 (25.4)	0.13 (3.2)	15000 (1034)
LPF8	HPF9	LPF8-FTM-HPF9-	1.87 (47.6)	1.19 (30.2)	0.19 (4.8)	15000 (1034)

## Low Pressure Female to Type M hose Male

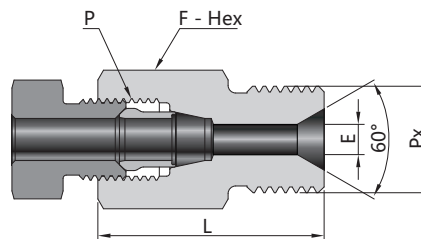

Low Pressure Female

Type M hose Male

P-Connection Type	PX-Connection Type	Ordering Number	Dimension, in. (mm)			Working Pressure psig (bar)
			L	F	E	
LPF2	RH9	LPF2-FTM-RH9-	1.06 (27.0)	0.63 (15.9)	0.09 (2.4)	15000 (1034)
LPF2	RH12	LPF2-FTM-RH12-	1.13 (28.6)	0.75 (19.1)	0.09 (2.4)	15000 (1034)
LPF4	RH9	LPF4-FTM-RH9-	1.37 (34.9)	0.63 (15.9)	0.09 (2.4)	15000 (1034)
LPF4	RH12	LPF4-FTM-RH12-	1.44 (36.5)	0.75 (19.1)	0.19 (4.8)	15000 (1034)
LPF4	RH14	LPF4-FTM-RH14-	1.63 (41.3)	1.00 (25.4)	0.15 (3.8)	15000 (1034)
LPF6	RH9	LPF6-FTM-RH9-	1.50 (38.1)	0.75 (19.1)	0.09 (2.4)	15000 (1034)
LPF6	RH12	LPF6-FTM-RH12-	1.63 (41.3)	0.75 (19.1)	0.25 (6.4)	15000 (1034)
LPF6	RH14	LPF6-FTM-RH14-	1.75 (44.5)	1.00 (25.4)	0.15 (3.8)	15000 (1034)
LPF6	RH16	LPF6-FTM-RH16-	1.63 (41.3)	1.00 (25.4)	0.25 (6.4)	15000 (1034)
LPF8	RH9	LPF8-FTM-RH9-	1.63 (41.3)	1.00 (25.4)	0.09 (2.4)	15000 (1034)
LPF8	RH12	LPF8-FTM-RH12-	1.63 (41.3)	1.00 (25.4)	0.29 (7.4)	15000 (1034)
LPF8	RH14	LPF8-FTM-RH14-	1.81 (46.1)	1.00 (25.4)	0.15 (3.8)	15000 (1034)
LPF8	RH16	LPF8-FTM-RH16-	1.75 (44.5)	1.00 (25.4)	0.37 (9.5)	15000 (1034)
LPF8	RH21	LPF8-FTM-RH21-	1.75 (44.5)	1.37 (34.9)	0.37 (9.5)	15000 (1034)

## Medium Pressure Female to Low Pressure Male

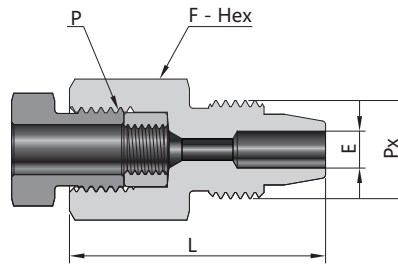

### Medium Pressure Female

### Low Pressure Male

P-Connection Type	PX-Connection Type	Ordering Number	Dimension, in. (mm)			Working Pressure psig (bar)
			L	F	E	
MPF4	LPF2	MPF4-FTM-LPF2-	1.19 (30.2)	0.63 (15.9)	0.09 (2.4)	15000 (1034)
MPF4	LPF4	MPF4-FTM-LPF4-	1.31 (33.3)	0.63 (15.9)	0.11 (2.8)	15000 (1034)
MPF4	LPF6	MPF4-FTM-LPF6-	1.37 (34.9)	0.75 (19.1)	0.11 (2.8)	15000 (1034)
MPF4	LPF8	MPF4-FTM-LPF8-	1.31 (33.3)	0.94 (23.8)	0.11 (2.8)	15000 (1034)
MPF6	LPF2	MPF6-FTM-LPF2-	1.50 (38.1)	0.75 (19.1)	0.09 (2.4)	15000 (1034)
MPF6	LPF4	MPF6-FTM-LPF4-	1.50 (38.1)	0.75 (19.1)	0.19 (4.8)	15000 (1034)
MPF6	LPF6	MPF6-FTM-LPF6-	1.56 (39.7)	0.75 (19.1)	0.20 (5.2)	15000 (1034)
MPF6	LPF8	MPF6-FTM-LPF8-	1.56 (39.7)	0.94 (23.8)	0.20 (5.2)	15000 (1034)
MPF9	LPF2	MPF9-FTM-LPF2-	1.75 (44.5)	1.00 (25.4)	0.09 (2.4)	15000 (1034)
MPF9	LPF4	MPF9-FTM-LPF4-	1.87 (47.6)	1.00 (25.4)	0.19 (4.8)	15000 (1034)
MPF9	LPF6	MPF9-FTM-LPF6-	1.94 (49.2)	1.00 (25.4)	0.25 (6.4)	15000 (1034)
MPF9	LPF8	MPF9-FTM-LPF8-	1.87 (47.6)	1.00 (25.4)	0.31 (7.9)	15000 (1034)
MPF12	LPF2	MPF12-FTM-LPF2-	2.06 (52.4)	1.37 (34.9)	0.09 (2.4)	15000 (1034)
MPF12	LPF4	MPF12-FTM-LPF4-	2.19 (55.6)	1.37 (34.9)	0.19 (4.8)	15000 (1034)
MPF12	LPF6	MPF12-FTM-LPF6-	2.19 (55.6)	1.37 (34.9)	0.25 (6.4)	15000 (1034)
MPF12	LPF8	MPF12-FTM-LPF8-	2.25 (57.2)	1.37 (34.9)	0.37 (7.9)	15000 (1034)
MPF16	LPF2	MPF16-FTM-LPF2-	2.63 (66.7)	1.75 (44.5)	0.09 (2.4)	15000 (1034)
MPF16	LPF4	MPF16-FTM-LPF4-	2.75 (69.9)	1.75 (44.5)	0.19 (4.8)	15000 (1034)
MPF16	LPF6	MPF16-FTM-LPF6-	2.81 (71.4)	1.75 (44.5)	0.25 (6.4)	15000 (1034)
MPF16	LPF8	MPF16-FTM-LPF8-	2.81 (71.4)	1.75 (44.5)	0.37 (9.5)	15000 (1034)

## Medium Pressure Female to Medium Pressure Male

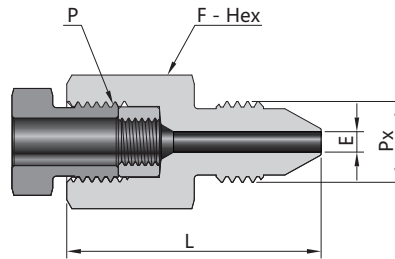

### Medium Pressure Female

### Medium Pressure Male

P-Connection Type	PX-Connection Type	Ordering Number	Dimension, in. (mm)			Working Pressure psig (bar)
			L	F	E	
MPF4	MPF4	MPF4-FTM-MPF4-	1.37 (34.9)	0.63 (15.9)	0.11 (2.8)	20000 (1379)
MPF4	MPF6	MPF4-FTM-MPF6-	1.50 (38.1)	0.63 (15.9)	0.11 (2.8)	20000 (1379)
MPF4	MPF9	MPF4-FTM-MPF9-	1.63 (41.3)	0.94 (23.8)	0.11 (2.8)	20000 (1379)
MPF4	MPF12	MPF4-FTM-MPF12-	1.75 (44.5)	1.19 (30.2)	0.11 (2.8)	20000 (1379)
MPF4	MPF16	MPF4-FTM-MPF16-	2.37 (60.3)	1.50 (38.1)	0.11 (2.8)	20000 (1379)
MPF6	MPF4	MPF6-FTM-MPF4-	1.69 (42.9)	0.75 (19.1)	0.11 (2.8)	20000 (1379)
MPF6	MPF6	MPF6-FTM-MPF6-	1.69 (42.9)	0.75 (19.1)	0.20 (5.2)	20000 (1379)
MPF6	MPF9	MPF6-FTM-MPF9-	1.87 (47.6)	0.94 (23.8)	0.20 (5.2)	20000 (1379)
MPF6	MPF12	MPF6-FTM-MPF12-	1.94 (49.2)	1.19 (30.2)	0.20 (5.2)	20000 (1379)
MPF6	MPF16	MPF6-FTM-MPF16-	2.37 (60.3)	1.50 (38.1)	0.20 (5.2)	20000 (1379)
MPF9	MPF4	MPF9-FTM-MPF4-	1.94 (49.2)	1.00 (25.4)	0.11 (2.8)	20000 (1379)
MPF9	MPF6	MPF9-FTM-MPF6-	2.06 (52.4)	1.00 (25.4)	0.20 (5.2)	20000 (1379)
MPF9	MPF9	MPF9-FTM-MPF9-	2.13 (54.0)	1.00 (25.4)	0.31 (7.9)	20000 (1379)
MPF9	MPF12	MPF9-FTM-MPF12-	2.25 (57.2)	1.19 (30.2)	0.31 (7.9)	20000 (1379)
MPF9	MPF16	MPF9-FTM-MPF16-	2.50 (63.5)	1.50 (38.1)	0.31 (7.9)	20000 (1379)
MPF12	MPF4	MPF12-FTM-MPF4-	2.19 (55.6)	1.37 (34.9)	0.11 (2.8)	20000 (1379)
MPF12	MPF6	MPF12-FTM-MPF6-	2.31 (58.7)	1.37 (34.9)	0.20 (5.2)	20000 (1379)
MPF12	MPF9	MPF12-FTM-MPF9-	2.44 (61.9)	1.37 (34.9)	0.31 (7.9)	20000 (1379)
MPF12	MPF12	MPF12-FTM-MPF12-	2.56 (65.1)	1.37 (34.9)	0.44 (11.1)	20000 (1379)
MPF12	MPF16	MPF12-FTM-MPF16-	2.94 (74.6)	1.50 (38.1)	0.44 (11.1)	20000 (1379)
MPF16	MPF9	MPF16-FTM-MPF9-	3.06 (77.8)	1.75 (44.5)	0.31 (7.9)	20000 (1379)
MPF16	MPF12	MPF16-FTM-MPF12-	3.19 (81.0)	1.75 (44.5)	0.44 (11.1)	20000 (1379)
MPF16	MPF16	MPF16-FTM-MPF16-	3.50 (88.9)	1.75 (44.5)	0.56 (14.3)	20000 (1379)

## Medium Pressure Female to High Pressure Male

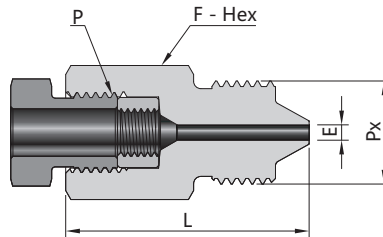

### Medium Pressure Female

### High Pressure Male

P-Connection Type	PX-Connection Type	Ordering Number	Dimension, in. (mm)			Working Pressure psig (bar)
			L	F	E	
MPF4	HPF4	MPF4-FTM-HPF4-	1.31 (33.3)	0.63 (15.9)	0.08 (2.1)	20000 (1379)
MPF4	HPF6	MPF4-FTM-HPF6-	1.50 (38.1)	0.81 (20.6)	0.11 (2.8)	20000 (1379)
MPF4	HPF9	MPF4-FTM-HPF9-	1.63 (41.3)	1.19 (30.2)	0.11 (2.8)	20000 (1379)
MPF6	HPF4	MPF6-FTM-HPF4-	1.50 (38.1)	0.75 (19.1)	0.08 (2.1)	20000 (1379)
MPF6	HPF6	MPF6-FTM-HPF6-	1.69 (42.9)	0.81 (20.6)	0.13 (3.2)	20000 (1379)
MPF6	HPF9	MPF6-FTM-HPF9-	1.75 (44.5)	1.19 (30.2)	0.19 (4.8)	20000 (1379)
MPF9	HPF4	MPF9-FTM-HPF4-	1.81 (46.0)	1.00 (25.4)	0.08 (2.1)	20000 (1379)
MPF9	HPF6	MPF9-FTM-HPF6-	2.13 (54.0)	1.00 (25.4)	0.13 (3.2)	20000 (1379)
MPF9	HPF9	MPF9-FTM-HPF9-	2.13 (54.0)	1.19 (30.2)	0.19 (4.8)	20000 (1379)
MPF12	HPF4	MPF12-FTM-HPF4-	2.25 (57.2)	1.37 (34.9)	0.08 (2.1)	20000 (1379)
MPF12	HPF6	MPF12-FTM-HPF6-	2.50 (63.5)	1.37 (34.9)	0.13 (3.2)	20000 (1379)
MPF12	HPF9	MPF12-FTM-HPF9-	2.50 (63.5)	1.37 (34.9)	0.19 (4.8)	20000 (1379)
MPF16	HPF4	MPF16-FTM-HPF4-	2.94 (74.6)	1.75 (44.5)	0.08 (2.1)	20000 (1379)
MPF16	HPF6	MPF16-FTM-HPF6-	3.13 (79.4)	1.75 (44.5)	0.13 (3.2)	20000 (1379)
MPF16	HPF9	MPF16-FTM-HPF9-	3.19 (81.0)	1.75 (44.5)	0.19 (4.8)	20000 (1379)

## Medium Pressure Female to Male NPT Thread

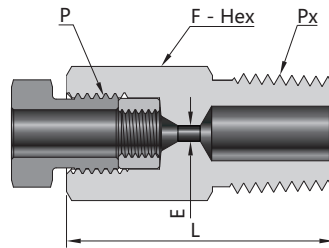

### Medium Pressure Female

### Male NPT Thread

P-Connection Type	PX-Connection Type	Ordering Number	Dimension, in. (mm)			Working Pressure psig (bar)
			L	F	E	
MPF4	1/8 Male NPT	MPF4-FTM-NPT2-	1.19 (30.2)	0.63 (15.9)	0.11 (2.8)	15000 (1034)
MPF4	1/4 Male NPT	MPF4-FTM-NPT4-	1.37 (34.9)	0.63 (15.9)	0.11 (2.8)	15000 (1034)
MPF4	3/8 Male NPT	MPF4-FTM-NPT6-	1.37 (34.9)	0.69 (17.5)	0.11 (2.8)	15000 (1034)
MPF4	1/2 Male NPT	MPF4-FTM-NPT8-	1.37 (34.9)	0.87 (22.2)	0.11 (2.8)	15000 (1034)
MPF4	3/4 Male NPT	MPF4-FTM-NPT12-	1.75 (44.5)	1.06 (27.0)	0.11 (2.8)	10000 (690)
MPF6	1/8 Male NPT	MPF6-FTM-NPT2-	1.37 (34.9)	0.75 (19.1)	0.19 (4.8)	15000 (1034)
MPF6	1/4 Male NPT	MPF6-FTM-NPT4-	1.50 (38.1)	0.75 (19.1)	0.20 (5.2)	15000 (1034)
MPF6	3/8 Male NPT	MPF6-FTM-NPT6-	1.50 (38.1)	0.75 (19.1)	0.20 (5.2)	15000 (1034)
MPF6	1/2 Male NPT	MPF6-FTM-NPT8-	1.63 (41.3)	0.87 (22.2)	0.20 (5.2)	15000 (1034)
MPF6	3/4 Male NPT	MPF6-FTM-NPT12-	1.75 (44.5)	1.06 (27.0)	0.20 (5.2)	10000 (690)
MPF6	1 Male NPT	MPF6-FTM-NPT16-	2.00 (50.8)	1.37 (34.9)	0.20 (5.2)	10000 (690)
MPF9	1/8 Male NPT	MPF9-FTM-NPT2-	1.75 (44.5)	1.00 (25.4)	0.19 (4.8)	15000 (1034)
MPF9	1/4 Male NPT	MPF9-FTM-NPT4-	1.75 (44.5)	1.00 (25.4)	0.25 (6.4)	15000 (1034)
MPF9	3/8 Male NPT	MPF9-FTM-NPT6-	1.75 (44.5)	1.00 (25.4)	0.31 (7.9)	15000 (1034)
MPF9	1/2 Male NPT	MPF9-FTM-NPT8-	1.94 (49.2)	1.00 (25.4)	0.31 (7.9)	15000 (1034)
MPF9	3/4 Male NPT	MPF9-FTM-NPT12-	2.00 (50.8)	1.06 (27.0)	0.31 (7.9)	10000 (690)
MPF9	1 Male NPT	MPF9-FTM-NPT16-	2.25 (57.2)	1.37 (34.9)	0.31 (7.9)	10000 (690)
MPF12	1/4 Male NPT	MPF12-FTM-NPT4-	2.00 (50.8)	1.37 (34.9)	0.25 (6.4)	15000 (1034)
MPF12	3/8 Male NPT	MPF12-FTM-NPT6-	2.00 (50.8)	1.37 (34.9)	0.31 (7.9)	15000 (1034)
MPF12	1/2 Male NPT	MPF12-FTM-NPT8-	2.19 (55.6)	1.37 (34.9)	0.38 (9.6)	15000 (1034)
MPF12	3/4 Male NPT	MPF12-FTM-NPT12-	2.25 (57.2)	1.37 (34.9)	0.44 (11.1)	10000 (690)
MPF12	1 Male NPT	MPF12-FTM-NPT16-	2.63 (66.7)	1.37 (34.9)	0.44 (11.1)	10000 (690)
MPF16	1/4 Male NPT	MPF16-FTM-NPT4-	2.87 (73.0)	1.75 (44.5)	0.25 (6.4)	15000 (1034)
MPF16	3/8 Male NPT	MPF16-FTM-NPT6-	2.87 (73.0)	1.75 (44.5)	0.31 (7.9)	15000 (1034)
MPF16	1/2 Male NPT	MPF16-FTM-NPT8-	2.87 (73.0)	1.75 (44.5)	0.38 (9.6)	15000 (1034)
MPF16	3/4 Male NPT	MPF16-FTM-NPT12-	2.87 (73.0)	1.75 (44.5)	0.56 (14.3)	10000 (690)
MPF16	1 Male NPT	MPF16-FTM-NPT16-	3.06 (77.8)	1.75 (44.5)	0.56 (14.3)	10000 (690)

## Medium Pressure Female to Type M hose Male

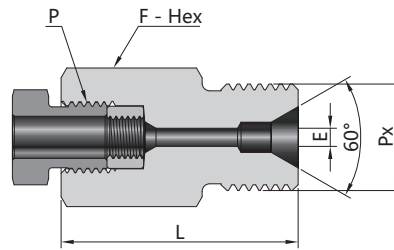

### Medium Pressure Female

### Type M hose Male

P-Connection Type	PX-Connection Type	Ordering Number	Dimension, in. (mm)			Working Pressure psig (bar)
			L	F	E	
MPF4	RH9	MPF4-FTM-RH9-	1.19 (30.2)	0.63 (15.9)	0.09 (2.4)	20000 (1379)
MPF4	RH12	MPF4-FTM-RH12-	1.31 (33.3)	0.75 (19.1)	0.11 (2.8)	20000 (1379)
MPF4	RH14	MPF4-FTM-RH14-	1.50 (38.1)	1.00 (25.4)	0.11 (2.8)	20000 (1379)
MPF6	RH9	MPF6-FTM-RH9-	1.37 (34.9)	0.75 (19.1)	0.09 (2.4)	20000 (1379)
MPF6	RH12	MPF6-FTM-RH12-	1.50 (38.1)	0.75 (19.1)	0.09 (2.4)	20000 (1379)
MPF6	RH14	MPF6-FTM-RH14-	1.63 (41.3)	1.00 (25.4)	0.15 (3.8)	20000 (1379)
MPF6	RH16	MPF6-FTM-RH16-	1.63 (41.3)	1.00 (25.4)	0.20 (5.2)	20000 (1379)
MPF9	RH9	MPF9-FTM-RH9-	1.69 (42.9)	1.00 (25.4)	0.09 (2.4)	20000 (1379)
MPF9	RH12	MPF9-FTM-RH12-	1.81 (46.0)	1.00 (25.4)	0.29 (7.4)	20000 (1379)
MPF9	RH14	MPF9-FTM-RH14-	1.94 (49.2)	1.00 (25.4)	0.15 (3.8)	20000 (1379)
MPF9	RH16	MPF9-FTM-RH16-	1.81 (46.0)	1.00 (25.4)	0.31 (7.9)	20000 (1379)
MPF9	RH21	MPF9-FTM-RH21-	1.81 (46.0)	1.37 (34.9)	0.31 (7.9)	20000 (1379)
MPF12	RH14	MPF12-FTM-RH12-	2.19 (55.6)	1.37 (34.9)	0.15 (3.8)	20000 (1379)
MPF12	RH16	MPF12-FTM-RH14-	2.13 (54.0)	1.37 (34.9)	0.39 (10.0)	20000 (1379)
MPF12	RH21	MPF12-FTM-RH16-	2.00 (50.8)	1.37 (34.9)	0.44 (11.1)	20000 (1379)
MPF16	RH21	MPF12-FTM-RH21-	2.56 (65.1)	1.75 (44.5)	0.56 (14.3)	20000 (1379)



## High Pressure Female to Low Pressure Male

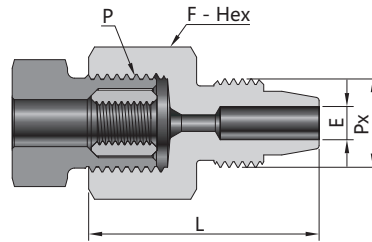

High Pressure Female

Low Pressure Male

P-Connection Type	PX-Connection Type	Ordering Number	Dimension, in. (mm)			Working Pressure psig (bar)
			L	F	E	
HPF4	LPF2	HPF4-FTM-LPF2-	1.19 (30.2)	0.75 (19.1)	0.09 (2.4)	15000 (1034)
HPF4	LPF4	HPF4-FTM-LPF4-	1.31 (33.3)	0.75 (19.1)	0.09 (2.4)	15000 (1034)
HPF4	LPF6	HPF4-FTM-LPF6-	1.37 (34.9)	0.75 (19.1)	0.09 (2.4)	15000 (1034)
HPF4	LPF8	HPF4-FTM-LPF8-	1.37 (34.9)	0.94 (23.8)	0.09 (2.4)	15000 (1034)
HPF6	LPF2	HPF6-FTM-LPF2-	1.44 (36.5)	1.00 (25.4)	0.09 (2.4)	15000 (1034)
HPF6	LPF4	HPF6-FTM-LPF4-	1.56 (39.7)	1.00 (25.4)	0.13 (3.2)	15000 (1034)
HPF6	LPF6	HPF6-FTM-LPF6-	1.63 (41.3)	1.00 (25.4)	0.13 (3.2)	15000 (1034)
HPF6	LPF8	HPF6-FTM-LPF8-	1.69 (42.9)	1.00 (25.4)	0.13 (3.2)	15000 (1034)
HPF9	LPF2	HPF9-FTM-LPF2-	1.75 (44.5)	1.37 (34.9)	0.09 (2.4)	15000 (1034)
HPF9	LPF4	HPF9-FTM-LPF4-	1.75 (44.5)	1.37 (34.9)	0.19 (4.8)	15000 (1034)
HPF9	LPF6	HPF9-FTM-LPF6-	1.81 (46.0)	1.37 (34.9)	0.19 (4.8)	15000 (1034)
HPF9	LPF8	HPF9-FTM-LPF8-	1.87 (47.6)	1.37 (34.9)	0.19 (4.8)	15000 (1034)

## High Pressure Female to Medium Pressure Male

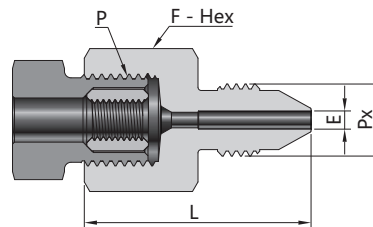

High Pressure Female

Medium Pressure Male

P-Connection Type	PX-Connection Type	Ordering Number	Dimension, in. (mm)			Working Pressure psig (bar)
			L	F	E	
HPF4	MPF4	HPF4-FTM-MPF4-	1.37 (34.9)	0.75 (19.1)	0.09 (2.4)	20000 (1379)
HPF4	MPF6	HPF4-FTM-MPF6-	1.50 (38.1)	0.75 (19.1)	0.09 (2.4)	20000 (1379)
HPF4	MPF9	HPF4-FTM-MPF9-	1.69 (42.9)	0.94 (23.8)	0.09 (2.4)	20000 (1379)
HPF4	MPF12	HPF4-FTM-MPF12-	1.75 (44.5)	1.19 (30.2)	0.09 (2.4)	20000 (1379)
HPF4	MPF16	HPF4-FTM-MPF16-	2.37 (60.3)	1.50 (38.1)	0.09 (2.4)	20000 (1379)
HPF6	MPF4	HPF6-FTM-MPF4-	1.67 (42.3)	1.00 (25.4)	0.11 (2.8)	20000 (1379)
HPF6	MPF6	HPF6-FTM-MPF6-	1.81 (46.0)	1.00 (25.4)	0.13 (3.2)	20000 (1379)
HPF6	MPF9	HPF6-FTM-MPF9-	1.94 (49.2)	1.00 (25.4)	0.13 (3.2)	20000 (1379)
HPF6	MPF12	HPF6-FTM-MPF12-	2.13 (54.0)	1.19 (30.2)	0.13 (3.2)	20000 (1379)
HPF6	MPF16	HPF6-FTM-MPF16-	2.50 (63.5)	1.50 (38.1)	0.13 (3.2)	20000 (1379)
HPF9	MPF4	HPF9-FTM-MPF4-	1.87 (47.6)	1.37 (34.9)	0.11 (2.8)	20000 (1379)
HPF9	MPF6	HPF9-FTM-MPF6-	2.00 (50.8)	1.37 (34.9)	0.19 (4.8)	20000 (1379)
HPF9	MPF9	HPF9-FTM-MPF9-	2.19 (55.6)	1.37 (34.9)	0.19 (4.8)	20000 (1379)
HPF9	MPF12	HPF9-FTM-MPF12-	2.37 (60.3)	1.37 (34.9)	0.19 (4.8)	20000 (1379)
HPF9	MPF16	HPF9-FTM-MPF16-	2.81 (71.4)	1.50 (38.1)	0.19 (4.8)	20000 (1379)

## High Pressure Female to High Pressure Male

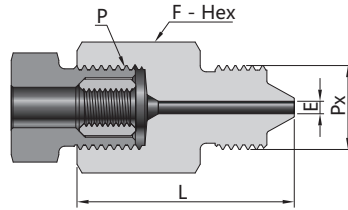

High Pressure Female

High Pressure Male

P-Connection Type	PX-Connection Type	Ordering Number	Dimension, in. (mm)			Working Pressure psig (bar)
			L	F	E	
HPF4	HPF4	HPF4-FTM-HPF4-	1.44 (36.5)	0.75 (19.1)	0.08 (2.1)	60000 (4137)
HPF4	HPF6	HPF4-FTM-HPF6-	1.69 (42.9)	0.81 (20.6)	0.09 (2.4)	60000 (4137)
HPF4	HPF9	HPF4-FTM-HPF9-	1.75 (44.5)	1.19 (30.2)	0.09 (2.4)	60000 (4137)
HPF6	HPF4	HPF6-FTM-HPF4-	1.75 (44.5)	1.00 (25.4)	0.08 (2.1)	60000 (4137)
HPF6	HPF6	HPF6-FTM-HPF6-	2.00 (50.8)	1.00 (25.4)	0.13 (3.2)	60000 (4137)
HPF6	HPF9	HPF6-FTM-HPF9-	2.13 (54.0)	1.19 (30.2)	0.13 (3.2)	60000 (4137)
HPF9	HPF4	HPF9-FTM-HPF4-	2.06 (52.4)	1.37 (34.9)	0.08 (2.1)	60000 (4137)
HPF9	HPF6	HPF9-FTM-HPF6-	2.37 (60.3)	1.37 (34.9)	0.13 (3.2)	60000 (4137)
HPF9	HPF9	HPF9-FTM-HPF9-	2.50 (63.5)	1.37 (34.9)	0.19 (4.8)	60000 (4137)

## High Pressure Female to Male NPT Thread

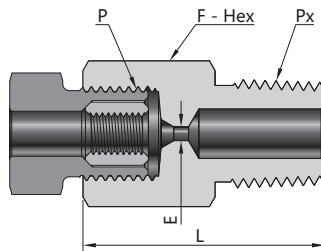

High Pressure Female

Male NPT Threads

P-Connection Type	PX-Connection Type	Ordering Number	Dimension, in. (mm)			Working Pressure psig (bar)
			L	F	E	
HPF4	1/8 Male NPT	HPF4-FTM-NPT2-	1.25 (31.8)	0.75 (19.1)	0.09 (2.4)	15000 (1034)
HPF4	1/4 Male NPT	HPF4-FTM-NPT4-	1.37 (34.9)	0.75 (19.1)	0.09 (2.4)	15000 (1034)
HPF4	3/8 Male NPT	HPF4-FTM-NPT6-	1.37 (34.9)	0.75 (19.1)	0.09 (2.4)	15000 (1034)
HPF4	1/2 Male NPT	HPF4-FTM-NPT8-	1.50 (38.1)	0.87 (22.2)	0.09 (2.4)	15000 (1034)
HPF4	3/4 Male NPT	HPF4-FTM-NPT12-	1.75 (44.5)	1.06 (27.0)	0.09 (2.4)	10000 (690)
HPF6	1/8 Male NPT	HPF6-FTM-NPT2-	1.50 (38.1)	1.00 (25.4)	0.13 (3.2)	15000 (1034)
HPF6	1/4 Male NPT	HPF6-FTM-NPT4-	1.63 (41.3)	1.00 (25.4)	0.13 (3.2)	15000 (1034)
HPF6	3/8 Male NPT	HPF6-FTM-NPT6-	1.63 (41.3)	1.00 (25.4)	0.13 (3.2)	15000 (1034)
HPF6	1/2 Male NPT	HPF6-FTM-NPT8-	1.75 (44.5)	1.00 (25.4)	0.13 (3.2)	15000 (1034)
HPF6	3/4 Male NPT	HPF6-FTM-NPT12-	2.00 (50.8)	1.06 (27.0)	0.13 (3.2)	10000 (690)
HPF6	1 Male NPT	HPF6-FTM-NPT16-	2.00 (50.8)	1.37 (34.9)	0.13 (3.2)	10000 (690)
HPF9	1/8 Male NPT	HPF9-FTM-NPT2-	1.63 (41.3)	1.37 (34.9)	0.19 (4.8)	15000 (1034)
HPF9	1/4 Male NPT	HPF9-FTM-NPT4-	1.75 (44.5)	1.37 (34.9)	0.19 (4.8)	15000 (1034)
HPF9	3/8 Male NPT	HPF9-FTM-NPT6-	1.75 (44.5)	1.37 (34.9)	0.19 (4.8)	15000 (1034)
HPF9	1/2 Male NPT	HPF9-FTM-NPT8-	1.87 (47.6)	1.37 (34.9)	0.19 (4.8)	15000 (1034)
HPF9	3/4 Male NPT	HPF9-FTM-NPT12-	2.13 (54.0)	1.37 (34.9)	0.19 (4.8)	10000 (690)
HPF9	1 Male NPT	HPF9-FTM-NPT16-	2.25 (57.2)	1.37 (34.9)	0.19 (4.8)	10000 (690)

## High Pressure Female to Type M hose Male

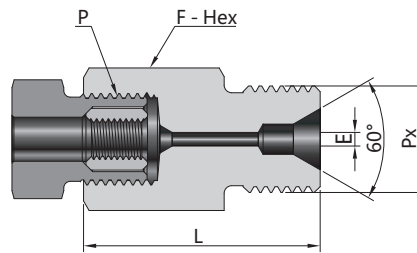

High Pressure Female

Type M hose Male

P-Connection Type	PX-Connection Type	Ordering Number	Dimension, in. (mm)			Working Pressure psig (bar)
			L	F	E	
HPF4	RH9	HPF4-FTM-RH9-	1.25 (31.8)	0.75 (19.1)	0.09 (2.4)	30000 (2068)
HPF4	RH12	HPF4-FTM-RH12-	1.38 (35.0)	0.75 (19.1)	0.09 (2.4)	30000 (2068)
HPF4	RH14	HPF4-FTM-RH14-	1.56 (39.7)	1.00 (25.4)	0.09 (2.4)	30000 (2068)
HPF4	RH16	HPF4-FTM-RH16-	1.37 (34.9)	1.00 (25.4)	0.09 (2.4)	20000 (1379)
HPF6	RH9	HPF6-FTM-RH9-	1.50 (38.1)	1.00 (25.4)	0.09 (2.4)	30000 (2068)
HPF6	RH12	HPF6-FTM-RH12-	1.63 (41.3)	1.00 (25.4)	0.13 (3.2)	30000 (2068)
HPF6	RH14	HPF6-FTM-RH14-	1.81 (46.0)	1.00 (25.4)	0.13 (3.2)	30000 (2068)
HPF6	RH16	HPF6-FTM-RH16-	1.64 (41.6)	1.00 (25.4)	0.13 (3.2)	20000 (1379)
HPF6	RH21	HPF6-FTM-RH21-	1.56 (39.7)	1.37 (34.9)	0.13 (3.2)	20000 (1379)
HPF9	RH14	HPF9-FTM-RH14-	2.00 (50.8)	1.37 (34.9)	0.15 (3.8)	30000 (2068)
HPF9	RH16	HPF9-FTM-RH16-	1.81 (46.0)	1.37 (34.9)	0.19 (4.8)	20000 (1379)
HPF9	RH21	HPF9-FTM-RH21-	1.81 (46.0)	1.37 (34.9)	0.19 (4.8)	20000 (1379)

## Female NPT Threads to Low Pressure Male

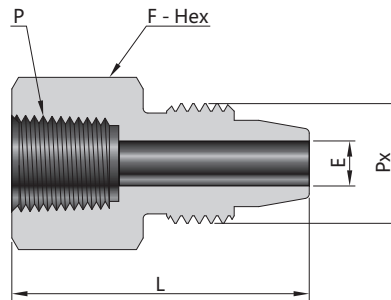

### Female NPT Threads

### Low Pressure Male

P-Connection Type	PX-Connection Type	Ordering Number	Dimension, in. (mm)			Working Pressure psig (bar)
			L	F	E	
1/8 Female NPT	LPF2	FNPT2-FTM-LPF2-	1.13 (28.6)	0.63 (15.9)	0.09 (2.4)	15000 (1034)
1/8 Female NPT	LPF4	FNPT2-FTM-LPF4-	1.25 (31.7)	0.63 (15.9)	0.19 (4.8)	15000 (1034)
1/8 Female NPT	LPF6	FNPT2-FTM-LPF6-	1.31 (33.3)	0.75 (19.1)	0.25 (6.4)	15000 (1034)
1/8 Female NPT	LPF8	FNPT2-FTM-LPF8-	1.31 (33.3)	0.94 (23.8)	0.37 (9.5)	15000 (1034)
1/4 Female NPT	LPF2	FNPT4-FTM-LPF2-	1.31 (33.3)	0.94 (23.8)	0.09 (2.4)	15000 (1034)
1/4 Female NPT	LPF4	FNPT4-FTM-LPF4-	1.50 (38.1)	0.94 (23.8)	0.19 (4.8)	15000 (1034)
1/4 Female NPT	LPF6	FNPT4-FTM-LPF6-	1.56 (39.7)	0.94 (23.8)	0.25 (6.4)	15000 (1034)
1/4 Female NPT	LPF8	FNPT4-FTM-LPF8-	1.56 (39.7)	0.94 (23.8)	0.37 (9.5)	15000 (1034)
3/8 Female NPT	LPF2	FNPT6-FTM-LPF2-	1.44 (36.5)	1.13 (28.6)	0.09 (2.4)	15000 (1034)
3/8 Female NPT	LPF4	FNPT6-FTM-LPF4-	1.56 (39.7)	1.13 (28.6)	0.19 (4.8)	15000 (1034)
3/8 Female NPT	LPF6	FNPT6-FTM-LPF6-	1.63 (41.3)	1.13 (28.6)	0.25 (6.4)	15000 (1034)
3/8 Female NPT	LPF8	FNPT6-FTM-LPF8-	1.69 (42.9)	1.13 (28.6)	0.37 (9.5)	15000 (1034)
1/2 Female NPT	LPF2	FNPT8-FTM-LPF2-	1.63 (41.3)	1.37 (34.9)	0.09 (2.4)	15000 (1034)
1/2 Female NPT	LPF4	FNPT8-FTM-LPF4-	1.75 (44.5)	1.37 (34.9)	0.19 (4.8)	15000 (1034)
1/2 Female NPT	LPF6	FNPT8-FTM-LPF6-	1.87 (47.6)	1.37 (34.9)	0.25 (6.4)	15000 (1034)
1/2 Female NPT	LPF8	FNPT8-FTM-LPF8-	1.87 (47.6)	1.37 (34.9)	0.37 (9.5)	15000 (1034)
3/4 Female NPT	LPF2	FNPT12-FTM-LPF2-	1.69 (42.9)	1.50 (38.1)	0.09 (2.4)	10000 (690)
3/4 Female NPT	LPF4	FNPT12-FTM-LPF4-	1.87 (47.6)	1.50 (38.1)	0.19 (4.8)	10000 (690)
3/4 Female NPT	LPF6	FNPT12-FTM-LPF6-	1.94 (49.2)	1.50 (38.1)	0.25 (6.4)	10000 (690)
3/4 Female NPT	LPF8	FNPT12-FTM-LPF8-	1.94 (49.2)	1.50 (38.1)	0.37 (9.5)	10000 (690)
1 Female NPT	LPF2	FNPT16-FTM-LPF2-	2.00 (50.8)	1.75 (44.5)	0.09 (2.4)	10000 (690)
1 Female NPT	LPF4	FNPT16-FTM-LPF4-	2.13 (54.0)	1.75 (44.5)	0.19 (4.8)	10000 (690)
1 Female NPT	LPF6	FNPT16-FTM-LPF6-	2.19 (55.6)	1.75 (44.5)	0.25 (6.4)	10000 (690)
1 Female NPT	LPF8	FNPT16-FTM-LPF8-	2.19 (55.6)	1.75 (44.5)	0.37 (9.5)	10000 (690)

## Female NPT Threads to Medium Pressure Male 20 Series Male

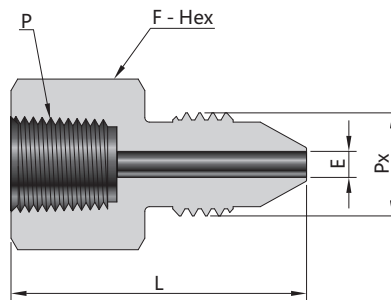

### Female NPT Threads

### Medium Pressure Male

P-Connection Type	PX-Connection Type	Ordering Number	Dimension, in. (mm)			Working Pressure psig (bar)
			L	F	E	
1/8 Female NPT	MPF4	FNPT2-FTM-MPF4-	1.25 (31.8)	0.63 (15.9)	0.11 (2.8)	15000 (1034)
1/8 Female NPT	MPF6	FNPT2-FTM-MPF6-	1.37 (34.9)	0.63 (15.9)	0.20 (5.2)	15000 (1034)
1/8 Female NPT	MPF9	FNPT2-FTM-MPF9-	1.50 (38.1)	0.94 (23.8)	0.31 (7.9)	15000 (1034)
1/8 Female NPT	MPF12	FNPT2-FTM-MPF12-	1.75 (44.5)	1.19 (30.2)	0.31 (7.9)	15000 (1034)
1/8 Female NPT	MPF16	FNPT2-FTM-MPF16-	2.37 (60.3)	1.50 (38.1)	0.31 (7.9)	15000 (1034)
1/4 Female NPT	MPF4	FNPT4-FTM-MPF4-	1.44 (36.5)	0.94 (23.8)	0.11 (2.8)	15000 (1034)
1/4 Female NPT	MPF6	FNPT4-FTM-MPF6-	1.63 (41.3)	0.94 (23.8)	0.20 (5.2)	15000 (1034)
1/4 Female NPT	MPF9	FNPT4-FTM-MPF9-	1.75 (44.5)	0.94 (23.8)	0.31 (7.9)	15000 (1034)
1/4 Female NPT	MPF12	FNPT4-FTM-MPF12-	1.87 (47.6)	1.19 (30.2)	0.41 (10.4)	15000 (1034)
1/4 Female NPT	MPF16	FNPT4-FTM-MPF16-	2.37 (60.3)	1.50 (38.1)	0.41 (10.4)	15000 (1034)
3/8 Female NPT	MPF4	FNPT6-FTM-MPF4-	1.50 (38.1)	1.13 (28.6)	0.11 (2.8)	15000 (1034)
3/8 Female NPT	MPF6	FNPT6-FTM-MPF6-	1.69 (42.9)	1.13 (28.6)	0.20 (5.2)	15000 (1034)
3/8 Female NPT	MPF9	FNPT6-FTM-MPF9-	1.81 (46.0)	1.13 (28.6)	0.31 (7.9)	15000 (1034)
3/8 Female NPT	MPF12	FNPT6-FTM-MPF12-	2.00 (50.8)	1.19 (30.2)	0.44 (11.1)	15000 (1034)
3/8 Female NPT	MPF16	FNPT6-FTM-MPF16-	2.37 (60.3)	1.50 (38.1)	0.56 (14.3)	15000 (1034)
1/2 Female NPT	MPF4	FNPT8-FTM-MPF4-	1.75 (44.5)	1.37 (34.9)	0.11 (2.8)	15000 (1034)
1/2 Female NPT	MPF6	FNPT8-FTM-MPF6-	1.87 (47.6)	1.37 (34.9)	0.20 (5.2)	15000 (1034)
1/2 Female NPT	MPF9	FNPT8-FTM-MPF9-	2.06 (52.4)	1.37 (34.9)	0.31 (7.9)	15000 (1034)
1/2 Female NPT	MPF12	FNPT8-FTM-MPF12-	2.19 (55.6)	1.37 (34.9)	0.44 (11.1)	15000 (1034)
1/2 Female NPT	MPF16	FNPT8-FTM-MPF16-	2.56 (65.1)	1.50 (38.1)	0.56 (14.3)	15000 (1034)
3/4 Female NPT	MPF4	FNPT12-FTM-MPF4-	1.81 (46.0)	1.50 (38.1)	0.11 (2.8)	10000 (690)
3/4 Female NPT	MPF6	FNPT12-FTM-MPF6-	1.94 (49.2)	1.50 (38.1)	0.20 (5.2)	10000 (690)
3/4 Female NPT	MPF9	FNPT12-FTM-MPF9-	2.13 (54.0)	1.50 (38.1)	0.31 (7.9)	10000 (690)
3/4 Female NPT	MPF12	FNPT12-FTM-MPF12-	2.31 (58.7)	1.50 (38.1)	0.44 (11.1)	10000 (690)
3/4 Female NPT	MPF16	FNPT12-FTM-MPF16-	2.75 (69.9)	1.50 (38.1)	0.56 (14.3)	10000 (690)
1 Female NPT	MPF4	FNPT16-FTM-MPF4-	2.06 (52.4)	1.75 (44.5)	0.11 (2.8)	10000 (690)
1 Female NPT	MPF6	FNPT16-FTM-MPF6-	2.19 (55.6)	1.75 (44.5)	0.20 (5.2)	10000 (690)
1 Female NPT	MPF9	FNPT16-FTM-MPF9-	2.44 (61.9)	1.75 (44.5)	0.31 (7.9)	10000 (690)
1 Female NPT	MPF12	FNPT16-FTM-MPF12-	2.56 (63.5)	1.75 (44.5)	0.44 (11.1)	10000 (690)
1 Female NPT	MPF16	FNPT16-FTM-MPF16-	3.06 (77.8)	1.75 (44.5)	0.56 (14.3)	10000 (690)

## Female NPT Threads to High Pressure Male

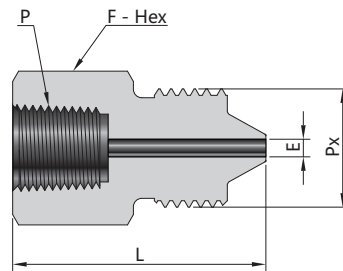

### Female NPT Threads

### High Pressure Male

P-Connection Type	PX-Connection Type	Ordering Number	Dimension, in. (mm)			Working Pressure psig (bar)
			L	F	E	
1/8 Female NPT	HPF4	FNPT2-FTM-HPF4-	1.19 (30.2)	0.63 (15.9)	0.08 (2.1)	15000 (1034)
1/8 Female NPT	HPF6	FNPT2-FTM-HPF6-	1.37 (34.9)	0.81 (20.6)	0.13 (3.2)	15000 (1034)
1/8 Female NPT	HPF9	FNPT2-FTM-HPF9-	1.63 (41.3)	1.19 (30.2)	0.19 (4.8)	15000 (1034)
1/4 Female NPT	HPF4	FNPT4-FTM-HPF4-	1.37 (34.9)	0.94 (23.8)	0.08 (2.1)	15000 (1034)
1/4 Female NPT	HPF6	FNPT4-FTM-HPF6-	1.63 (41.3)	0.94 (23.8)	0.13 (3.2)	15000 (1034)
1/4 Female NPT	HPF9	FNPT4-FTM-HPF9-	1.75 (44.5)	1.19 (30.2)	0.19 (4.8)	15000 (1034)
3/8 Female NPT	HPF4	FNPT6-FTM-HPF4-	1.44 (36.5)	1.13 (28.6)	0.08 (2.1)	15000 (1034)
3/8 Female NPT	HPF6	FNPT6-FTM-HPF6-	1.69 (42.9)	1.13 (28.6)	0.13 (3.2)	15000 (1034)
3/8 Female NPT	HPF9	FNPT6-FTM-HPF9-	1.81 (46.0)	1.19 (30.2)	0.19 (4.8)	15000 (1034)
1/2 Female NPT	HPF4	FNPT8-FTM-HPF4-	1.69 (42.9)	1.37 (34.9)	0.08 (2.1)	15000 (1034)
1/2 Female NPT	HPF6	FNPT8-FTM-HPF6-	1.94 (49.2)	1.37 (34.9)	0.13 (3.2)	15000 (1034)
1/2 Female NPT	HPF9	FNPT8-FTM-HPF9-	2.13 (54.0)	1.37 (34.9)	0.19 (4.8)	15000 (1034)
3/4 Female NPT	HPF4	FNPT12-FTM-HPF4-	1.75 (44.5)	1.50 (38.1)	0.08 (2.1)	10000 (690)
3/4 Female NPT	HPF6	FNPT12-FTM-HPF6-	2.00 (50.8)	1.50 (38.1)	0.13 (3.2)	10000 (690)
3/4 Female NPT	HPF9	FNPT12-FTM-HPF9-	2.19 (55.6)	1.50 (38.1)	0.19 (4.8)	10000 (690)
1 Female NPT	HPF4	FNPT16-FTM-HPF4-	2.00 (50.8)	1.75 (44.5)	0.08 (2.1)	10000 (690)
1 Female NPT	HPF6	FNPT16-FTM-HPF6-	2.25 (57.2)	1.75 (44.5)	0.13 (3.2)	10000 (690)
1 Female NPT	HPF9	FNPT16-FTM-HPF9-	2.44 (61.9)	1.75 (44.5)	0.19 (4.8)	10000 (690)

# Medium Pressure Fittings Nipples and Tubing

20 Series, 20,000 psi (1379 bar)



- ❖ Coned-and-Threaded Connection
- ❖ Available sizes are 1/4, 3/8, 9/16, 3/4, and 1 in.
- ❖ Working temperature from -423°F to 1200°F (-252°C to 649°C)
- ❖ Special 316 stainless steel and Alloy 826 material

## Typical 20 Series fittings Assemblies

- ❖ Coned-and-Threaded Connection
- ❖ Available sizes are 1/4, 3/8, 9/16, 3/4, and 1 in.
- ❖ Working temperature from -423°F to 1200°F (-252°C to 649°C)
- ❖ Special 316 stainless steel and Alloy 826 material
- ❖ Anti-vibration connection components available
- ❖ Hikelok 20 series medium pressure fittings are designed for use with 20 series medium pressure valves

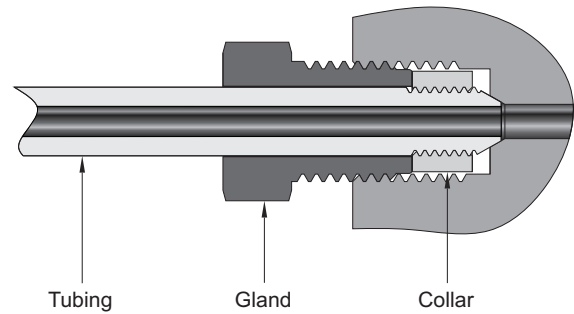

### Dimensions

#### Glands

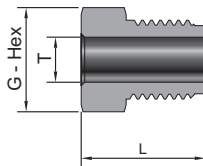

T-Tube O.D. in.	Basic Ordering Number	Dimensions, in. (mm)	
		G	L
1/4	20G-MPF4-	0.50 (12.7)	0.58 (14.7)
3/8	20G-MPF6-	0.63 (15.9)	0.73 (18.5)
9/16	20G-MPF9-	0.94 (23.8)	0.88 (22.4)
3/4	20G-MPF12-	1.19 (30.2)	1.00 (25.4)
1	20G-MPF16-	1.38 (34.9)	1.38 (35.1)

#### Collars

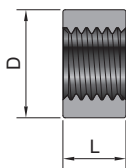

T-Tube O.D. in.	Basic Ordering Number	Dimensions, in. (mm)	
		D	L
1/4	20C-MPF4-	0.38 (9.7)	0.22 (5.6)
3/8	20C-MPF6-	0.47 (11.9)	0.25 (6.4)
9/16	20C-MPF9-	0.72 (18.3)	0.31 (7.9)
3/4	20C-MPF12-	0.94 (23.8)	0.37 (9.4)
1	20C-MPF16-	1.25 (31.8)	0.50 (12.7)

#### Plugs

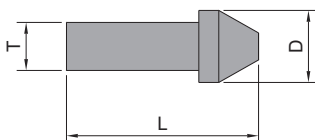

T-Tube O.D. in.	Basic Ordering Number	Dimensions, in. (mm)	
		D	L
1/4	20P-MPF4-	0.38 (9.7)	0.94 (23.8)
3/8	20P-MPF6-	0.47 (11.9)	1.18 (30.0)
9/16	20P-MPF9-	0.72 (18.3)	1.40 (35.6)
3/4	20P-MPF12-	0.94 (23.8)	1.69 (42.9)
1	20P-MPF16-	1.25 (31.8)	2.20 (55.9)



## Union Couplings

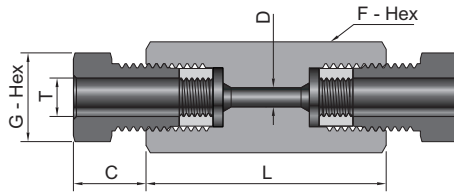

T-Tube O.D. in.	Basic Ordering Number	Dimensions, in. (mm)				
		L	C	D	G	F
1/4	20U-MPF4-	1.62 (41.1)	0.38 (9.7)	0.11 (2.8)	0.50 (12.7)	0.63 (15.9)
3/8	20U-MPF6-	1.75 (44.5)	0.44 (11.2)	0.20 (5.1)	0.63 (15.9)	0.75 (19.1)
9/16	20U-MPF9-	2.12 (53.9)	0.53 (13.5)	0.31 (7.9)	0.94 (23.8)	1.00 (25.4)
3/4	20U-MPF12-	2.50 (63.5)	0.62 (15.7)	0.44 (11.1)	1.19 (30.2)	1.38 (34.9)
1	20U-MPF16-	3.50 (88.9)	0.72 (18.3)	0.56 (14.3)	1.38 (34.9)	1.75 (44.5)

## Reducing Union Couplings

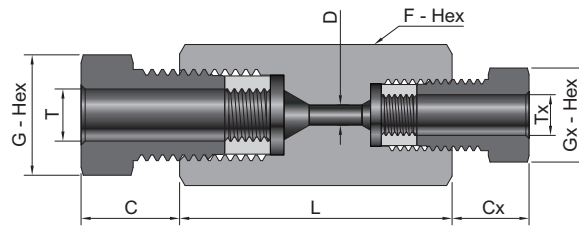

T-Tube O.D. in.	Tx-Tube O.D. in.	Basic Ordering Number	Dimensions, in. (mm)						
			L	C	Cx	D	G	Gx	F
3/8	1/4	MPF6-20RU-MPF4-	1.75 (44.5)	0.44 (11.2)	0.38 (9.7)	0.11 (2.8)	0.63 (15.9)	0.50 (12.7)	0.75 (19.1)
9/16	1/4	MPF9-20RU-MPF4-	2.00 (50.8)	0.53 (13.5)	0.38 (9.7)	0.11 (2.8)	0.94 (23.8)	0.50 (12.7)	1.00 (25.4)
9/16	3/8	MPF9-20RU-MPF6-	2.00 (50.8)	0.53 (13.5)	0.44 (11.2)	0.20 (5.1)	0.94 (23.8)	0.63 (15.9)	1.00 (25.4)
3/4	1/4	MPF12-20RU-MPF4-	2.25 (57.2)	0.62 (15.7)	0.38 (9.7)	0.11 (2.8)	1.19 (30.2)	0.50 (12.7)	1.38 (34.9)
3/4	3/8	MPF12-20RU-MPF6-	2.25 (57.2)	0.62 (15.7)	0.44 (11.2)	0.20 (5.1)	1.19 (30.2)	0.63 (15.9)	1.38 (34.9)
3/4	9/16	MPF12-20RU-MPF9-	2.50 (63.5)	0.62 (15.7)	0.53 (13.5)	0.31 (7.9)	1.19 (30.2)	0.94 (23.8)	1.38 (34.9)
1	1/4	MPF16-20RU-MPF4-	2.75 (69.9)	0.72 (18.3)	0.38 (9.7)	0.11 (2.8)	1.38 (34.9)	0.50 (12.7)	1.75 (44.5)
1	3/8	MPF16-20RU-MPF6-	2.88 (73.0)	0.72 (18.3)	0.44 (11.2)	0.20 (5.1)	1.38 (34.9)	0.63 (15.9)	1.75 (44.5)
1	9/16	MPF16-20RU-MPF9-	3.00 (76.2)	0.72 (18.3)	0.53 (13.5)	0.31 (7.9)	1.38 (34.9)	0.94 (23.8)	1.75 (44.5)
1	3/4	MPF16-20RU-MPF12-	3.00 (76.2)	0.72 (18.3)	0.62 (15.7)	0.44 (11.1)	1.38 (34.9)	1.19 (30.2)	1.75 (44.5)

## Union Couplings (Slip Type)

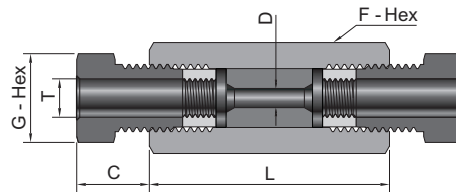

T-Tube O.D. in.	Basic Ordering Number	Dimensions, in. (mm)				
		L	C	D	G	F
1/4	20SU-MPF4-	1.62 (41.1)	0.38 (9.7)	0.11 (2.8)	0.50 (12.7)	0.63 (15.9)
3/8	20SU-MPF6-	1.75 (44.5)	0.44 (11.2)	0.20 (5.1)	0.63 (15.9)	0.75 (19.1)
9/16	20SU-MPF9-	2.12 (53.9)	0.53 (13.5)	0.31 (7.9)	0.94 (23.8)	1.00 (25.4)
3/4	20SU-MPF12-	2.50 (63.5)	0.62 (15.7)	0.44 (11.1)	1.19 (30.2)	1.38 (34.9)
1	20SU-MPF16-	3.50 (88.9)	0.72 (18.3)	0.56 (14.3)	1.38 (34.9)	1.75 (44.5)

## Bulkhead Couplings

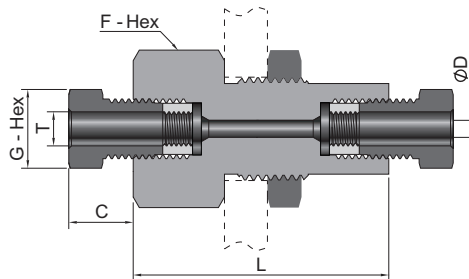

T-Tube O.D. in.	Basic Ordering Number	Dimensions, in. (mm)					Panel Hole Size	Max. Panel Thickness
		L	C	D	G	F		
1/4	20BU-MPF4-	1.88 (47.8)	0.38 (9.7)	0.11 (2.8)	0.50 (12.7)	1.00 (25.4)	0.81 (20.6)	0.38 (9.7)
3/8	20BU-MPF6-	2.00 (50.8)	0.44 (11.2)	0.20 (5.1)	0.63 (15.9)	1.06 (27.0)	0.94 (23.9)	0.38 (9.7)
9/16	20BU-MPF9-	2.38 (60.5)	0.53 (13.5)	0.31 (7.9)	0.94 (23.8)	1.38 (34.9)	1.13 (28.6)	0.38 (9.7)
3/4	20BU-MPF12-	2.62 (66.5)	0.62 (15.7)	0.44 (11.1)	1.19 (30.2)	1.88 (47.6)	1.69 (42.9)	0.38 (9.7)
1	20BU-MPF16-	3.50 (88.9)	0.72 (18.3)	0.56 (14.3)	1.38 (34.9)	2.13 (54.0)	1.94 (49.3)	0.38 (9.7)

## Caps

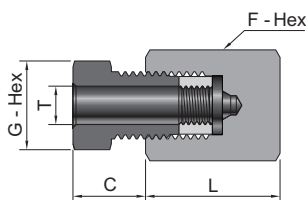

T-Tube O.D. in.	Basic Ordering Number	Dimensions, in. (mm)			
		L	C	G	F
1/4	20CA-MPF4-	0.81 (20.6)	0.38 (9.7)	0.50 (12.7)	0.63 (15.9)
3/8	20CA-MPF6-	1.13 (28.6)	0.44 (11.2)	0.63 (15.9)	0.75 (19.1)
9/16	20CA-MPF9-	1.38 (34.9)	0.53 (13.5)	0.94 (23.8)	1.00 (25.4)
3/4	20CA-MPF12-	1.75 (44.5)	0.62 (15.7)	1.19 (30.2)	1.38 (34.9)
1	20CA-MPF16-	2.25 (57.2)	0.72 (18.3)	1.38 (34.9)	1.75 (44.5)

## Elbows

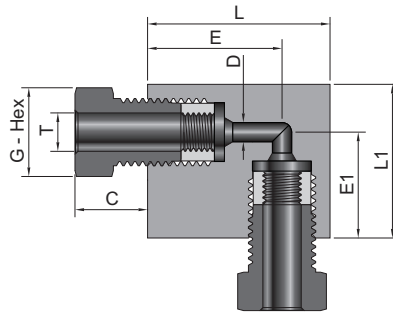

T-Tube O.D. in.	Basic Ordering Number	Dimensions, in. (mm)							
		C	D	G	L	E	L1	E1	Thickness
1/4	20UE-MPF4-	0.38 (9.7)	0.11 (2.8)	0.50 (12.7)	1.12 (28.4)	0.75 (19.1)	1.12 (28.4)	0.75 (19.1)	0.63 (15.9)
3/8	20UE-MPF6-	0.44 (11.2)	0.20 (5.1)	0.63 (15.9)	1.38 (34.9)	1.00 (25.4)	1.38 (34.9)	1.00 (25.4)	0.75 (19.1)
9/16	20UE-MPF9-	0.53 (13.5)	0.31 (7.9)	0.94 (23.8)	1.75 (44.5)	1.25 (31.8)	1.75 (44.5)	1.25 (31.8)	1.00 (25.4)
3/4	20UE-MPF12-	0.62 (15.7)	0.44 (11.1)	1.19 (30.2)	2.25 (57.2)	1.50 (38.1)	2.25 (57.2)	1.50 (38.1)	1.38 (34.9)
1	20UE-MPF16-	0.72 (18.3)	0.56 (14.3)	1.38 (34.9)	3.00 (76.2)	2.06 (52.3)	3.00 (76.2)	2.06 (52.3)	1.75 (44.5)

## Tees

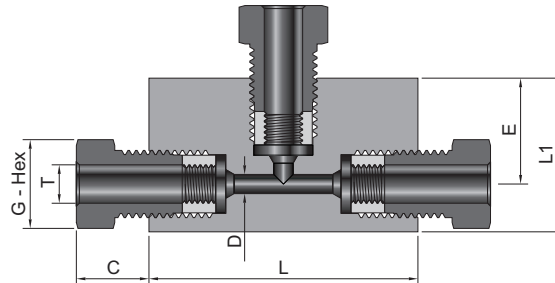

T-Tube O.D. in.	Basic Ordering Number	Dimensions, in. (mm)							
		C	D	G	L	L1	E	Thickness	
1/4	20UT-MPF4-	0.38 (9.7)	0.11 (2.8)	0.50 (12.7)	1.50 (38.1)	1.12 (28.4)	0.75 (19.1)	0.63 (15.9)	
3/8	20UT-MPF6-	0.44 (11.2)	0.20 (5.1)	0.63 (15.9)	2.00 (50.8)	1.38 (34.9)	1.00 (25.4)	0.75 (19.1)	
9/16	20UT-MPF9-	0.53 (13.5)	0.31 (7.9)	0.94 (23.8)	2.50 (63.5)	1.75 (44.5)	1.25 (31.8)	1.00 (25.4)	
3/4	20UT-MPF12-	0.62 (15.7)	0.44 (11.1)	1.19 (30.2)	3.00 (76.2)	2.25 (57.2)	1.50 (38.1)	1.38 (34.9)	
1	20UT-MPF16-	0.72 (18.3)	0.56 (14.3)	1.38 (34.9)	4.12 (104.6)	3.00 (76.2)	2.06 (52.3)	1.75 (44.5)	

## Crosses

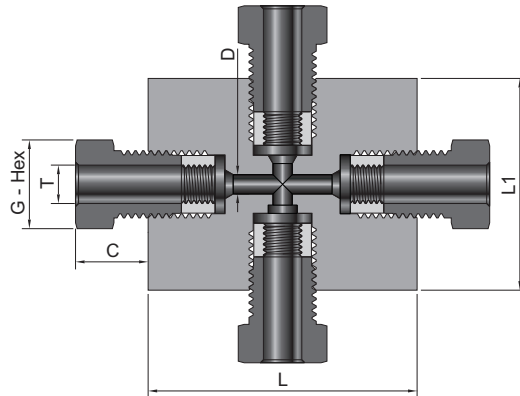

T-Tube O.D. in.	Basic Ordering Number	Dimensions, in. (mm)					
		C	D	G	L	L1	Thickness
1/4	20UC-MPF4-	0.38 (9.7)	0.11 (2.8)	0.50 (12.7)	1.50 (38.1)	1.50 (38.1)	0.63 (15.9)
3/8	20UC-MPF6-	0.44 (11.2)	0.20 (5.1)	0.63 (15.9)	2.00 (50.8)	2.00 (50.8)	0.75 (19.1)
9/16	20UC-MPF9-	0.53 (13.5)	0.31 (7.9)	0.94 (23.8)	2.50 (63.5)	2.50 (63.5)	1.00 (25.4)
3/4	20UC-MPF12-	0.62 (15.7)	0.44 (11.1)	1.19 (30.2)	3.00 (76.2)	3.00 (76.2)	1.38 (34.9)
1	20UC-MPF16-	0.72 (18.3)	0.56 (14.3)	1.38 (34.9)	4.12 (104.6)	4.12 (104.6)	1.75 (44.5)

## Ordering Information

❖ To order Hikelok 20 series medium pressure fittings, add the material designator (316 or A825) to the ordering number